



K.S.R.M. COLLEGE OF ENGINEERING (UGC-AUTONOMOUS)

Kadapa, Andhra Pradesh, India- 516 003
Approved by AICTE, New Delhi & Affiliated to JNTUA,
Ananthapuramu.



An ISO 14001:2004 & 9001: 2015 Certified Institution

5.1.3 The following Capacity Development and Skill Enhancement activities are organized for improving students' capabilities

Awareness of trends in technology

Consolidated list for Academic
year From 2018-2019 to 2022-
2023

S.No	Name of the capability enhancement program	Date of implementation (DD-MM-YYYY)	Number of students enrolled	Name of the agencies/experts involved with contact details (if any)
Academic Year 2022-2023				
1	Workshop on Game Design using Build Box	From 04-07-2022 to 08-07-2022	44	Sri C.Sathish Kumar, APSSDC Mentor, Vijayawada, AP
2	Workshop on FPGA Implementation of Digital Circuits using Vivado	From 04-07-2022 to 05-07-2022	26	Miss S.Jabeen & Smt K.Divya Lakshmi, KSRMCE, Kadapa, AP
3	Workshop on How to Prepare to Get Job in Product Based Company	22-07-2022	72	Dr G.Murali, JNTUACEP, Pulivendula, Kadapa, AP
4	Workshop on Game Design using Unity 3D	From 25-07-2022 to 30-07-2022	29	Sri C.Sathish Kumar, APSSDC Mentor, Vijayawada, AP
5	Guest Lecture on Entrepreneurship, Innovation and Design Thinkong	20-08-2022	47	Ms.C.Silpa, Dr Avanija, Dr R. Madhavi & Mr M.J . Uday kumar, MBU School of Computing, Tirupathi, AP

6	Workshop on Employability Skills Enhancement Training	From 29-08-2022 to 03-09-2022	40	Allavarapu Geetha & Sri Sai Ganesh Kumar, APSSDC, Vijayawada, AP
7	Workshop on Embedded systems and IOT	From 05-09-2022 to 09-09-2022	57	Sri Kushal Nesarkar, Embedded System Engineer, Edgate
8	Field Visit to Construction of Sai Gold Plaza, near Yerraguntla bypass road, Proddatur, Kadapa	06-09-2022	48	Sri P.Pavan Kumar & K. Hemanth Kumar, Kadapa, AP
9	Field Visit to Geophysical Investigation for Groundwater Detection, Kadapa	15-09-2022	50	Sri U.Imran Basha, Kadapa, AP
10	Field visit on the Retrofitting of Rajiv Park, Kadapa	17-09-2022	22	Sri P.Rajendra Kumar & P.Pavan Kumar, KSRMCE, Kadapa, AP
11	workshop on virtual lab	From 19-09-2022 to 24-09-2022	437	Smt.M.Mary Jasmine & Smt Dr R. Joyce Stella, KSRM College of Engineering, Kadapa, AP
12	Workshop on Home Automation Project with Bolt IOT	08-10-2022	80	Sai Satheesh, Industry Experts, APSSDC, Vijayawada, AP
13	Guest lecture on superconductors and its applications	11-10-2022	135	Dr T. Amaranatha Reddy, Associative Professor, Aditya College of Engineering, Madanapalle, AP
14	Webinar on The Role of Block Chain in Education	13-10-2022	80	Mr. Sharath Babu Thirunagari, APSSDC Mentor, Vijayawada, AP
15	Workshop on Automatic Robotic Control	15-10-2022	116	Sri T.Vamsi Kalyan, Technical Trainer, Indo-Euro Synchronization Pvt Ltd, Bangalore, Karnataka
16	Workshop on Product Design and Drafting by CATIA	From 17-10-2022 to 22-10-2022	31	Sri D.Rambabu, APSSDC Trainer
17	Workshop on Architectural Modelling using Revit	From 17-10-2022 to 22-10-2022	38	Miss M.Pravallika, APSSDC Trainer, Vijayawada, AP
18	Workshop on C Programming and Data Structures	From 25-10-2022 to 29-10-2022	65	IBM Certified Trainer, Bangalore, Karnataka
19	Guest Lecture on Embedded Systems Hardware Board Design	02-11-2022	153	Sri A. Venkata Siva Reddy, MD&CEO, GND Solutions, Bengaluru, Karnataka
20	Motivational Programme	11-11-2022	336	Mr B. Subramanyam, Unacademy, Bangalore
21	Workshop on Autocad	From 14-11-2022 to 19-11-2022	39	Sri D.Ram Babu, APSSDC Trainer, Vijayawada, AP
22	Awareness Program on CSI	17-11-2022	48	Smt B.Swetha & Sri A.Ramprakash Reddy, KSRMCE, Kadapa, AP

23	Awareness and Benefits of IEEE Women in Engineering	17-11-2022	50	Dr.M.Aruna Bharathi,Geetananjali Engineering College,Hyderabad
24	Guest lecture on preparing for success from day one	18-11-2022	59	Dr Dinakar Dantala,NIT, Warangal,Telangana
25	Awareness Program on Industries	24-11-2022	75	Sri A.V.Siva Reddy , CEO,GND Solutions,Banglore,Karnataka
26	Wrokshop on IOT & Its Applications	17-12-2022	43	Mr K.Kalyan Kumar & Mr N.Siddhik,KSRM College of Engineering,Kadapa,AP
27	Guest Lecture on AL Vs ML Vs DL	21-12-2022	50	Dr M. Krishnamurthy,KCG College of Technology,Chennai,Tamilnadu
28	Poster Presentation on Indian Culture & Tradition with Practices	02-01-2023	52	Sri J.Sunil ,KSRM College of Engineering,Kadapa,AP
29	Guest Lecture on Career Opportunities in Digital Era	04-01-2023	46	Sri K.Gnanashekar,Business Development Keylynk Business Consulting Pvt Ltd,Bangolre
30	Workshop on PCB Design	From 30-01-2023 to 04-02-2023	61	Sri M.Uma Maheswara Rao & Sri M.Kuldeep Reddy,APSSDC Trainer,Vijayawada,AP
31	Workshop on Production Design and Drafting by Catia	From 06-02-2023 to 10-02-2023	42	Sri U Pradeep Kumar,APSSDC Trainer,Vijayawada,AP
32	Industrial Visit to IBM Company	From 09-02-2023 to 10-02-2023	44	Sri J.Sunil ,KSRM College of Engineering,Kadapa,AP
33	Workshop on PLC Fundamentals	From 13-02-2023 to 18-02-2023	58	Sri M.Uma Maheswara Rao & Sri M.Kuldeep Reddy,APSSDC Trainer,Vijayawada,AP
34	Field vist to Sewage Treatment Plant and Irrigation Structures in Pulivendula	16-02-2023	86	Dr T.Kiran Kumar & Sri P.Pavan Kumar,KSRMCE,Kadapa,AP
35	Seminar on Achieving Problem-Solution Fit & Product-Market fit	16-02-2023	75	Mr V. Akbar Basha,Chief Executive officer,S.K. University,AP
36	Field visit on Biogas Plant, Kadapa	04-03-2023	47	Prof T.Kiran Kumar,KSRMCE,Kadapa,AP
37	Webinar on Expert Talk on Carrier Opportunities for engineering Graduates	17-03-2023	40	Dr. VRDM Kausik Agastya Raj,AP
38	Field visit to Installation of proflex sheet of indoor stadium,KSRMCE,Kadapa	18-03-2023	64	Sri k.Hemanth kumar Reddy,KSRMCE,Kadapa,AP

39	Field visit to Erection of structural members in solar bike and car parking,KSRMCE,Kadapa	25-03-2023	51	Dr B.Sudheer Kumar Reddy , KSRMCE,Kadapa,AP
40	Workshop on Python Programming	From 27-03-2023 to 01-04-2023	64	Sri N. Ravi Kumar,APSSDC Trainer,Vijayawada,AP
41	Wrokshop on Design Thinking,Critical thinking and Innovation Design	10-04-2023	46	Mr.Mohammed Labid Khan,CEO,Muntaz Energy Pvt.Ltd,Ananthapur
42	Webinar on AR Vs VR	11-04-2023	59	Miss Hari Priya Manne,Software Developer,Banglore,Karnataka
43	Awareness program on IUCEE	20-04-2023	44	Sri R. V. Sreehari,KSRM College of Engineering,Kadapa,AP
44	Guest Lecture on Endogenous Brain Switch	28-04-2023	185	Sri C.Sivananda Reddy,Research scholar,IIT Madras,Chennai
45	Workshop on CNC	From 04-05-2023 to 05-05-2023	60	Sri U Pradeep Kumar,APSSDC Trainer,Vijayawada,AP
46	Wrokshop on Advanced Python Programming	From 15-05-2023 to 17-05-2023	49	Smt B.Swetha & Smt K.Sujana Kumari ,KSRMCE,Kadapa,AP
47	Seminar on Recycling and its effects on our environment	20-05-2023	61	Sri K.Ramachandraiah,Manager,ITCWO W,Banglore,Karnataka
48	Guest Lecture on Advance Manufacturing Systems	24-05-2023	47	Dr.P.Vamsi Krishna,NIIT,Warangal,Telangana
49	Workshop on Building Drafting using Autocad	From 05-06-2023 to 10-06-2023	39	Sri V.Brahmesh,APSSDC Trainer,Vijayawada,AP
50	Guest Lecture by IBM on Data Wrangling and Data Cleaning	30-06-2023	63	Ms Arpith Jain,COO,IBM,Banglore,Karnataka
Academic Year 2021-2022				
51	Workshop on "SDLC in Real-time projects & Induction on Application Development"	From 27-08-2021 to 28-08-2021	203	Sadik Shaik,HR Executive,Cignex Datamatics,Bengaluru,Karnataka
52	Webinar on Super Conductors	31-08-2021	116	Dr T.Ravindra Reddy,Assistant Professor,AITK,Kadapa,AP
53	Workshop on App Development without coding	03-09-2021	60	Sri S.Khaja Khizar,Assistant Professor,KSRMCE,Kadapa,AP
54	One Day Webinar on Current Trends, Applications & Future	09-09-2021	55	Sri C.Sivananda Reddy,Assistant professor,JNTU Pulivendula,Kadapa,AP

	Prospects in Nanotechnology			
55	Seminar on Python IDE's	12-09-2021	98	Dr N.Ramanjaneya Reddy ,KSRMCE,Kadapa,AP
56	Field visit to Gambrel Engineers LLP	16-09-2021	76	Sri p.Pavan Kumar & Sri C.H santosh Kumar,KSRMCE,Kadapa,AP
57	Field Visit to Gambrel Engineers LLP to visit a Construction of function hall	16-09-2021	76	Miss V Sai Neeraja & Sri C.H santosh Kumar,KSRMCE,Kadapa,AP
58	Wrokshop on Autcad Hackathon	From 17-09-2021 to 18-09-2021	41	Sri B.Srihari & Sri S.Mahaboob Khan ,KSRMCE,Kadapa,AP
59	Guest Lecture on Optical Fibers and its Application	20-09-2021	85	Dr T.Amaranatha Reddy,Associate Profesor,Aditya College of Engineering, Madanapalle,AP
60	Guest Lecture on Metal matrix a composite material	25-09-2021	53	Sri B.Vishnu Vardhan Naidu,Sree Vidyanikenthan Engineering College,Tirupathi,AP
61	Webinar on "Synchronization of TDMA bursts with short preamble for Geo satellite Receiver	28-09-2021	124	Sri Naru Pradeep,Senior Research Engineer,CDOT,Banglore,Karnataka
62	Guest lecture on Overview of Data Mining	28-09-2021	35	Dr N.Madhusudhana Reddy,RGM College of Engineering,Nandyal,Kurnool,AP
63	Workshop on "IoT, Embedded Systems and Robotics"	From 29-09-2021 to 01-10-2021	47	Sri T.Krishna Chaithanya,Embedded System Engineer Edgate Technologies,Banglore,Karnataka
64	Guest Lecture on Water Budget Estimation in Rayalaseema	30-09-2021	70	Prof T.Kiran Kumar,KSRMCE,Kadapa,AP
65	Guest Lecture on Industrial Automation & Control	04-10-2021	38	Dr S. M.A.K. versity,APAzad,VIT University,AP
66	Workshop on Industrial Automation using PLC	From 04-10-2021 to 09-10-2021	33	Mentors from APSSDC,Vijayawada,AP
67	Webinar on "Basics of .NET"	09-10-2021	50	Sri Y.Anumesh,Senior Software Engineer,Agree Ya Solutions,Bangalore,Karnataka.
68	Workshop on Soft Computing Techniques	From 12-10-2021 to 15-10-2021	28	DrT.Mariprasath,KSRMCE,Kadapa, AP
69	Workshop on "Ethical Hacking in association with Algrithm Edu-Space"	From 23-10-2021 to 24-10-2021	34	Mr Dawood Ansar,Certified EthicalHacker,Banglore,Karnataka
70	Workshop on Municipal Solid waste management	From 28-10-2021 to 30-10-2021	93	M.Safiya Banu,Assistant Engineer,Public Health Division ,Kadapa,AP

71	Industrial visit for Nagarjuna Sagar Tail Pond Dam Circle, Macharla	From 29-10-2021 to 30-10-2021	55	Mr G.Hussian Basha & MS A.Jyothirmayi,KSRMCE,Kadapa,AP
72	Awareness Programme on "Training & Placement"	01-11-2021	58	Sri Md Mahaboob Pasha,KSRMCE,Kadapa,AP
73	Workshop on Embedded Systems	From 08-11-2021 to 12-11-2021	20	Mentors from APSSDC,Vijayawada,AP
74	Awareness program on Internships	10-11-2021	80	Sri R.V. Sreehari,KSRM College of Engineering,Kadapa,AP
75	Workshop on Role of Irrigation projects on uplift in Rayalaseema	From 15-11-2021 to 16-11-2021	103	Sri U Ramesh,Executive Engineer,Kadapa,AP
76	Workshop on "PCB DESIGN"	From 17-11-2021 to 18-11-2021	85	Dr S. L.Prathapa Reddy,KSRM College of Engineering,Kadapa,AP
77	Guest Lecture on an overview of condition monitoring techniques into the diagnosis of machine elements	18-11-2021	53	Sri R.Mani Kumar,R&D Engineer,Trio vision,Kadapa,AP
78	Guest Lecture on Utilization of drones in modern surveying	26-11-2021	56	Sri M Gokul Selwa,Survey Engineer,coimbatore,Tamil Nadu
79	Guest Lecture on Energy Audit	27-11-2021	48	Sri T.Muthu Kumaran,Deputy Manager,Kadapa,AP
80	Guest lecture on "Machine Learning"	27-11-2021	92	Dr G.Murali ,JNTUACEP,Pulivendula,Kadapa,AP
81	Hackathon on indoor navigation System using Bluetooth and Beacon technology	From 03-12-2021 to 04-12-2021	140	Dr D.Arun Kumar & Mr S. Khaja Khizar,KSRMCE,Kadapa,AP
82	Role of Incubation cell Sustainable Technology Development	29-12-2021	45	Dr M.Ravindran ,Associate Professor,National Engineering College,Tamilnadu
83	Field visit to Contour Surveying using Total Station	19-01-2022	62	Dr I.Srinivasula Reddy,Sri P.Pavan Kumar, Miss V.Sai neeraja,KSRMCE,Kadapa,AP
84	Guest lecture on Smart Grid	31-01-2022	42	Dr. Y. V. Siva Reddy,Sub-Section,GPRCE,Kurnool,AP
85	Awareness program on "GATE"	01-02-2022	111	Sri S. Manimoerabadhan Trinath,ACE Engineering Academy,Hyderabad
86	Workshop on Autocad	From 03-02-2022 to 09-02-2022	31	Sri S.Arba Khan,Kadapa,AP
87	Workshop on G-Suite	From 03-02-2022 to 26-02-2022	400	Sri S.Khaja Khizar,Assistant Professor,KSRMCE,Kadapa,AP

88	Awareness Programm on Soft Skills	From 07-02-2022 to 10-02-2022	400	Sri K.Eswar Reddy,Assistant Professor,KSRMCE,Kadapa,AP
89	Guest Lecture on "RTL Design and Verification using VLSI"	09-02-2022	78	Sri M.Madana Gopal,AARK IC Technologies Pvt.Ltd,Baglore,Karnataka
90	Workshop on Introduction IOT	From 21-02-2022 to 26-02-2022	25	DrM.V.Narayana & Dr T. Mariprasath,KSRMCE,Kadapa,AP
91	Guest Lecture on Empowering youth minds with patriotism and truth	03-03-2022	120	Sri M.sree Hari,& M.Sreenivasa,Sri Vivekananda Junior College,Kadapa,AP
92	Guest Lecture on "5G massive MIMO and beam forming"	05-03-2022	105	Sri Naru Pradeep,Senior Research Engineer,CDOT,Banglore,Karnataka
93	Guest Lecture on "Artificial intelligence Applications in signal processing"	09-03-2022	80	Dr T.Kishore Kumar,Professor,NIT,Warangal
94	Internal Smart India Hackathon2022	16-03-2022	170	Dr C.Chandra Mouli,Technical Executive,AIC,SK Unniversity,Anatapur,AP
95	Guest Lecture on "Automation In Industry"	11-04-2022	58	Sri Makasam Sreedhar,Manager,Hindustan Aeronautics limited,Nasik,Maharashtra
96	Guest Lecture on Ultrasonic	29-04-2022	70	Dr M.Guru Bhaskar,Deparment of Physics,Y.V.University,Kadapa,AP
97	Webinar on SQUID's	04-05-2022	102	Dr G.Thirumala Rao ,Assistant Professor,GMRIT,Rajam
98	Guest Lecture on Organic Spectroscopy Applications for Engineers.	09-05-2022	96	Dr S.Venkata Lakshmi Reddy,Lecturer in Chemsitry,Govt Degree College foe women,Rayachoti,Kadapa,AP
99	Guest Lecture on Creative Techniques for Budding Engineers	26-05-2022	64	Sri Nandan Reddy,Managing Director,Trivision,Kadapa,AP
100	Workshop on NI MyDAQ hands on Experimentation	From 30-05-2022 to 04-06-2022	180	Dr T.Mariprasath & Dr P.Kishore ,KSRMCE,Kadapa,AP
101	Webinar on Non-Destructive Testing	02-06-2022	71	Sri Siddharth Chandra ,Faculty,Banglore,Karnataka
102	Online Workshop on Intellectual Property Rights (IPR) and Patents and Design Filing	08-06-2022	221	Dr.Pankaj Prabhakar Borkar,Deputy Controller of Patents and Designs,Mumbai
103	Guest Lecture on Emerging trends in remote sensing & GIS Application in Civil Engineering field	17-06-2022	52	Dr T.Siva Prathap,Associate Professor,Yogi Vemana University,Kadapa,AP

104	Guest Lecture on Prerequisites to be Design Engineer	30-06-2022	54	Mr Ashwin R L ,Assistant Manager,CADMAX Solutions,Banglore,Karnataka
Academic Year 2020-2021				
105	Guest lecture on latest technological insights in solar energy	15-09-2020	53	Sri L. Nanda kishore, Deputy Manager, BHEL Electronics division, Bangalore.
106	Guest lecture on Electric vehicles	24-09-2020	43	Dr. M. Naveen Kumar, Sr. Engineer & Consultant, VALEO
107	Workshop on Design of electrical circuits using Multisim	From 12-10-2020 to 14-10-2020	30	Smt. Saleha Tabassum, Ms. A. Jyothirmayi, Asst. prof/ EEE, KSRMCE.
108	Guest lecture on Renewable Energy system	10-11-2020	35	Srirama Chandra Murthy, DC, APTRANSCO,AP
109	Guest lecture on power system operation and its components	21-11-2020	49	Mr. B. Raju Garu, Divisional Engineer, APTRANSCO, Kadapa,AP
110	Guest lecture on Awareness for Mechanical students	14-12-2020	104	Sri B. Venkata Ramana Naik, Assistant Motor vehicle inspector,Kadapa,AP
111	Webinar on Fundamentals & Importance of Big Data	31-12-2020	70	Sri Y. Bhaskar Reddy, Asst. Prof/CSE, KSRMCE,Kadapa,AP
112	Seminar on Overview of Intellectual Property Rights	08-01-2021	50	Sri A. Valli Bhasha, Asst. prof./ ECE, KSRMCE,Kadapa,AP
113	Workshop on CATIA in association with Dassaults systems	From 18-02-2021 to 20-02-2021	25	Sri Dhakshinamurthi, Dassault systems, Andhra pradesh.
114	Guest lecture on Smart Grid- Net Metering	16-03-2021	35	C. Chandra sekhar, CPRI, Bangalore,Karnataka
115	Guest lecture on 3D part design, assembly and detailing using solid works	25-03-2021	62	Mrs. V. Sandhya Mohan, Senior Mechanical Design Engineer, Lion Laboratories
116	Guest Lecture on Missile Guidance & control	27-03-2021	66	Sri D. Sreenivasulu Reddy, Scientist, DRDL, DRDO, Hydrabad.
117	Guest lecture on Introduction to Missile systems & control technology	01-04-2021	60	D. Sreenivasulu Reddy, Scientist, DRDL, Hyderabad.
118	Webinar on Power BI	03-04-2021	65	Sri C. Sreedhar, Technical lead, INFOSYS BMP, Hyderabad
119	Guest lecture on Battery storage system	29-04-2021	32	Sri S. M. A. K. Azad, Sr. Asst. prof., VIT, AP.
120	Webinar on Current trends in Information Technology	11-05-2021	60	Sri M. V. S. Prasad, Senior project manager, INFOSYS, Hyderabad.
121	Webinar on Cloud computing Primer	15-05-2021	60	Sri S. Prasad Reddy, Senior IT Leader,GEAviation,Cincinnati, USA.

122	Guest Lecture on Introduction of Aviation	30-05-2021	32	Sri Avichandra.Y, IP Threat Assessment leader, General Electric, Bangalore.
123	Workshop on "PCB Design"	From 14-06-2021 to 03-07-2021	30	Ms. S. Teja sri, Trainer, APSSDC,Vijayawada,AP
124	Guest Lecture on Meta materials Microstrip Patch Antennas	17-06-2021	109	Dr. S. Sreenath kashyap, Vice principal, KPRIT, Hyderabad
125	Webinar on Cyber Security	19-06-2021	76	Sri Sai Sathish, CEO, Indian servers, Vijayawada,AP
126	Workshop on Photonics	From 28-06-2021 to 29-06-2021	50	Dr. T. Srinivas, IISc, Bang., Dr. G. Thavasi Raja, NIT, Trichy, Dr. Mandeep sing, NITK, Surathkal, Dr. Venkatesha M, senior member IEEE, Dr. D Sriram kumar, NIT, Trichy, Dr. KVSSSS Sairam, NMAMIT, Karnataka.
Academic Year 2019-2020				
127	Workshop on Robcad and Solid Edge Technologies	From 08-07-2019 to 20-07-2019	56	Sri D.Rambabu,APSSDC Trainer,Vijayawada,AP
128	Workshop on Keadership Development	28-08-2019	38	Dr G.Ashok Reddy,Assistant Professor,KSRMCE,Kadapa,AP
129	Guest Lecture on AI Applications in Singnal Processing	10-10-2019	48	Dr N.Sreekanth,Professor,MRCEW,Hyderabad
130	Seminar On Power of Body Language	31-10-2019	63	Sri K.Eswar Reddy,Assistant Professor,KSRMCE,Kadapa,AP
131	Seminar on Mathematics its History & Impotence	21-12-2019	54	Sri G.Sreedhar,Assistant Professor,KSRMCE,Kadapa,AP
132	Guest Lecture on Industrial Safety and Management	22-01-2020	41	Dr J.Chidanandappa,Scientist-E,NRSE,Hyderabad
133	Workshop on 3D Printing Software's for 3D Printer	25-01-2020	54	Dr B.Sudharsan,Associative Professor,KSRMCE,Kadapa,AP
134	Seminar on Awareness Program on GATE	30-01-2020	55	Dr M.Venkata Narayana, Professor,KSRMCE,Kadapa,AP
135	Guest Lecture on Computational Fluid Dyanamics and its Applications	25-02-2020	43	Dr A.Harish,Senior Project Scienst,IIT Madras,Chennai
Academic Year 2018-2019				
136	Seminar on Wireless Communication networks	14-09-2018	78	Sri S.L.Prathap Reddy,Assistant Professor,KSRMCE,Kadapa,AP
137	Workshop on IPR	From 17-12-2018 to 21-12-2018	62	Dr S.Skakeel Ahamad & Dr D.Krishna Mohan Raju,AITS,Rajampeta,Kadapa,AP
138	Awareness Program on Importance of Communication Skills	24-01-2019	36	Sri N.Bhaskara Reddy,Assistant Professor,KSRMCE,Kadapa,AP
139	Guest Lecture on Computer Aided Engineering using ANSYS	25-02-2019	43	Sri Abdul Sheik,Technical Manager,Kurnool,AP

140	Guest Lecture on Machine Learning	09-05-2019	52	Smt D.Balagiriya, Data Scientist, TCS, Hyderabad
-----	-----------------------------------	------------	----	--

IQAC
Co-ordinator
Internal Quality Assurance Cell (IQAC)
KSRM College of Engineering
Kadapa - 516 003

V. S. S. Mm/45
Principal
PRINCIPAL
K.S.R.M. COLLEGE OF ENGINEERING
KADAPA-516005, (A.P.)

GAME DESIGN USING BUILD BOX

4-7-22 to 8-7-22

I Year CSE



K.S.R.M. COLLEGE OF ENGINEERING (UGC-AUTONOMOUS)

Kadapa, Andhra Pradesh, India- 516 003

Approved by AICTE, New Delhi & Affiliated to JNTUA, Ananthapuramu.

An ISO 14001:2004 & 9001: 2015 Certified Institution

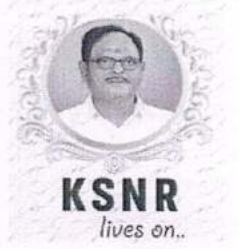

Lr./KSRMCE/SDC/2022-23/

Date:27-06-2022

To
The Principal,
KSRMCE,
Kadapa.

Respected Sir,

Sub: Permission to Organize a One Week Workshop on "GAME DESIGN USING BUILD BOX" from **04/07/2022 to 08/07/2022**-Req- Reg.

The Skill Development Cell is planning to organize a One Week Workshop on "GAME DESIGN USING BUILD BOX" for I Year B. Tech. students of CSE. The course will be conducted from **04/07/2022 to 08/07/2022**. In this regard, I kindly request you to grant permission to conduct One Week Workshop.

Thanking you sir,

Yours faithfully

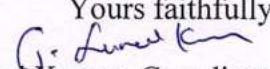
(G Suneel Kumar, Coordinator, S D Cell)

Permitted
U. S. S. Muneef



K.S.R.M. COLLEGE OF ENGINEERING (UGC-AUTONOMOUS)

Kadapa, Andhra Pradesh, India- 516 003

Approved by AICTE, New Delhi & Affiliated to JNTUA, Ananthapuramu.

An ISO 14001:2004 & 9001: 2015 Certified Institution



Cr./KSRMCE/SDC/2022-23/

Date: 29/06/2022

Circular

The Skill Development Cell is organizing a One Week Workshop on "GAME DESIGN USING BUILD BOX" from **04/07/2022 to 08/07/2022** to I Year B. Tech students of CSE. In this regard, interested students are requested to register their names for the One Week Workshop with the Coordinator.

For further information contact the Workshop Coordinator.

Workshop Coordinator: Smt. S Riyaz Banu, Asst. Professor, Dept. of CSE.-KSRMCE.

Contact No: 9182264678

V. S. S. Muelly

**PRINCIPAL
PRINCIPAL**

**K.S.R.M. COLLEGE OF ENGINEERING
KADAPA-516005, (A.P.)**

Cc to:

IQAC-KSRMCE



/kasmce.ac.in

Follow Us:



/kasmceofficial



K.S.R.M. COLLEGE OF ENGINEERING

(UGC-AUTONOMOUS)

Kadapa, Andhra Pradesh, India- 516 003

Approved by AICTE, New Delhi & Affiliated to JNTUA, Ananthapuramu.

An ISO 14001:2004 & 9001: 2015 Certified Institution



Date: 02-07-22

Name of the Event: One Week Workshop on “GAME DESIGN USING BUILD BOX”

Venue : PG 114

List of Participants

S. No	Name	Department	Roll No	Contact No./Email Id
1	C. PADMAJA	CSE	219Y1A0519	219Y1A0519@ksrmce.ac.in
2	D. V. PRUDVI RAJ ARYAN	CSE	219Y1A0537	219Y1A0537@ksrmce.ac.in
3	D. HARIKA	CSE	219Y1A0540	219Y1A0540@ksrmce.ac.in
4	D. SUMANTH	CSE	219Y1A0542	219Y1A0542@ksrmce.ac.in
5	G. SRAVANI	CSE	219Y1A0550	219Y1A0550@ksrmce.ac.in
6	G. SOWMYA	CSE	219Y1A0552	219Y1A0552@ksrmce.ac.in
7	G. HARSHITH SAI	CSE	219Y1A0557	219Y1A0557@ksrmce.ac.in
8	J. BHASKAR	CSE	219Y1A0566	219Y1A0566@ksrmce.ac.in
9	K.RAJ KUMAR	CSE	219Y1A0568	219Y1A0568@ksrmce.ac.in
10	K. MADHAVI	CSE	219Y1A0571	219Y1A0571@ksrmce.ac.in
11	K. KUSUMA	CSE	219Y1A0581	219Y1A0581@ksrmce.ac.in
12	K. KARTHICKEYA	CSE	219Y1A0583	219Y1A0583@ksrmce.ac.in
13	K. IBRAHIM	CSE	219Y1A0587	219Y1A0587@ksrmce.ac.in
14	K. SIVA NANDHINI	CSE	219Y1A0592	219Y1A0592@ksrmce.ac.in
15	M. NAGA SANTHOSH	CSE	219Y1A0594	219Y1A0594@ksrmce.ac.in
16	M. ANUSHA	CSE	219Y1A0595	219Y1A0595@ksrmce.ac.in
17	M. APARNA	CSE	219Y1A0596	219Y1A0596@ksrmce.ac.in
18	M. VENKATA SAI NIKHIL	CSE	219Y1A05A2	219Y1A05A2@ksrmce.ac.in
19	M. LAKSHMI BHAVANI	CSE	219Y1A05A7	219Y1A05A7@ksrmce.ac.in
20	M. ASIF	CSE	219Y1A05A8	219Y1A05A8@ksrmce.ac.in
21	M.VINILA	CSE	219Y1A05A9	219Y1A05A9@ksrmce.ac.in
22	M. SHASHA VALI	CSE	219Y1A05B5	219Y1A05B5@ksrmce.ac.in
23	N. RAFI	CSE	219Y1A05B7	219Y1A05B7@ksrmce.ac.in
24	N. RIYAZ	CSE	219Y1A05B8	219Y1A05B8@ksrmce.ac.in
25	N. SASIDHAR	CSE	219Y1A05C0	219Y1A05C0@ksrmce.ac.in
26	P. BABJAN	CSE	219Y1A05C8	219Y1A05C8@ksrmce.ac.in
27	P. SUMALATHA	CSE	219Y1A05D1	219Y1A05D1@ksrmce.ac.in
28	P. SAI KRISHNA	CSE	219Y1A05D4	219Y1A05D4@ksrmce.ac.in
29	P. SEERISHA	CSE	219Y1A05E1	219Y1A05E1@ksrmce.ac.in
30	R. ABHINASH	CSE	219Y1A05E4	219Y1A05E4@ksrmce.ac.in



31	S.SAI DIVYA	CSE	219Y1A05E9	219Y1A05E9@ksrmce.ac.in
32	S. SHASIKALA	CSE	219Y1A05G7	219Y1A05G7@ksrmce.ac.in
33	S. JAGADEESH	CSE	219Y1A05G8	219Y1A05G8@ksrmce.ac.in
34	T. JANARDHAN REDDY	CSE	219Y1A05H3	219Y1A05H3@ksrmce.ac.in
35	T. SAILAJA	CSE	219Y1A05H4	219Y1A05H4@ksrmce.ac.in
36	B. ALEKYA	CSE	219Y1A05I1	219Y1A05I1@ksrmce.ac.in
37	V. MANASA	CSE	219Y1A05I2	219Y1A05I2@ksrmce.ac.in
38	B. PRADEEP REDDY	CSE	219Y1A05I3	219Y1A05I3@ksrmce.ac.in
39	V. SREELAKSHMI	CSE	219Y1A05I4	219Y1A05I4@ksrmce.ac.in
40	V. RAJESWARI	CSE	219Y1A05I5	219Y1A05I5@ksrmce.ac.in
41	V. RAVI KUMAR	CSE	219Y1A05I7	219Y1A05I7@ksrmce.ac.in
42	V. POOJITHA	CSE	219Y1A05I8	219Y1A05I8@ksrmce.ac.in
43	Y. SUMALATHA	CSE	219Y1A05J3	219Y1A05J3@ksrmce.ac.in
44	Y. RAJA KUMAR REDDY	CSE	219Y1A05J6	219Y1A05J6@ksrmce.ac.in

[Handwritten Signature]
Coordinator

V. S. S. M. W. K.
Principal
K.S.R.M. COLLEGE OF ENGINEERING
KADAPA-516005, (A.P.)



K.S.R.M. COLLEGE OF ENGINEERING (UGC-AUTONOMOUS)

Kadapa, Andhra Pradesh, India- 516 003

Approved by AICTE, New Delhi & Affiliated to JNTUA, Ananthapuramu.

An ISO 14001:2004 & 9001: 2015 Certified Institution



SCHEDULE

Skill Development Cell

One Week Workshop

On

“Game Design using Build Box” From 04/07/2022 to 08/07/2022

Date	Timing	Resource Person	Topic to be covered
04/07/22	9 AM to 5 PM	C Sathish Kumar	Introduction to Gaming, Downloading & installing Build box software; Explaining software interface.
05/07/22	9 AM to 5 PM	C Sathish Kumar	What is Asset? And Assets Downloading, Importing background and its properties; What is transform and its properties.
06/07/22	9 AM to 5 PM	C Sathish Kumar	Importing Character and Explaining character Properties and Animations.
07/07/22	9 AM to 5 PM	C Sathish Kumar	What is an Object and its role; Explaining Object Instances.
08/07/22	9 AM to 5 PM	C Sathish Kumar	Sub-object custom component; What is Effect and Types of Effects. What is Logic and Types of Logic Items. Actions and UI.

Sathish Kumar
Resource Person

Pradeep Kumar
Coordinator

U. S. S. M. M. / 15
PRINCIPAL
PRINCIPAL
K.S.R.M. COLLEGE OF ENGINEERING
KADAPA-516005, (A.P.)



K.S.R.M. COLLEGE OF ENGINEERING

(UGC-AUTONOMOUS)

Kadapa, Andhra Pradesh, India- 516 003

Approved by AICTE, New Delhi & Affiliated to JNTUA, Ananthapuramu.

An ISO 14001:2004 & 9001: 2015 Certified Institution



**Report of
One Week Workshop on “Game Design using Build Box”
From 04/07/2022 to 08/07/2022**

Target Group	:	I B. Tech Students of CSE
Details of Participants	:	44 Students
Organizer	:	G Suneel Kumar
Resource Person	:	Sri C Sathish kumar
Organizing Department	:	Skill Development Cell
Venue	:	PG 114

Description:

The Skill Development Cell has organized a One week workshop on “Game Design using Build Box” from 04th July 2022 to 08th July 2022. The course Resource Person is Sri C Sathish Kumar, APSSDC Trainer.

The main objective of this course is to introduce Game Design concepts using Build box. Build box is the world's first software that truly allows anyone to create amazing games regardless of technical skill. Due to its unique user interface, making games becomes a fluid process that doesn't require any scripting, programming or software design experience. There's no coding skills or programming knowledge required.

This software was designed to allow anyone with an idea to dive straight in and start creating.

In Build box 2.0 you can create stage clear games that wildly open up gameplay possibilities. The multiple world features allow you to create multiple worlds to mix and match as you see fit. The options are endless. Make a simple casual game or a complex adventure game with text, playable cutscenes, and multiple themed worlds.

Animated menus are another new feature that lets users customize their players' gaming experience. Animate your menus or create your own complete cutscenes with our new keyframe animator. Build box 2.0 is loaded with new tools and editing options to easily add advanced elements into your game with minimal effort.

PHOTOS

The pictures taken during the course are given below:

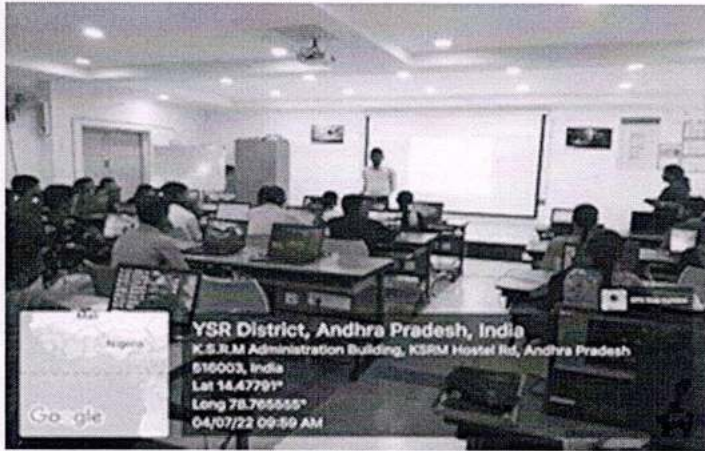

Resource Person giving introduction

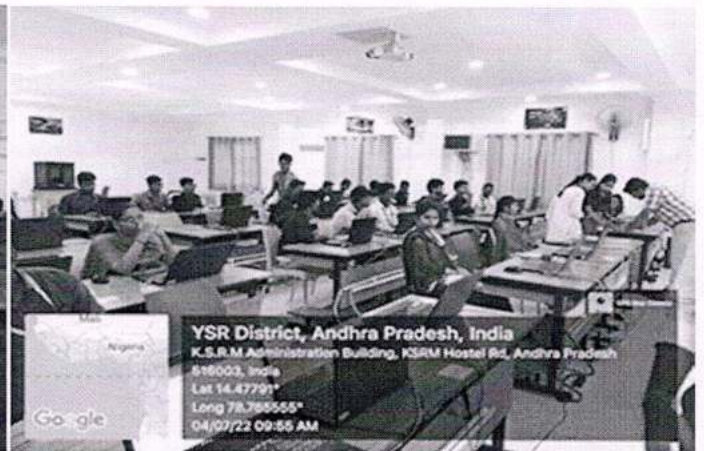

Resource Person explaining the concepts

Prof. N. S. Kumar
Coordinator

V. S. S. Murthy
Principal
PRINCIPAL
K.S.R.M. COLLEGE OF ENGINEERING
KADAPA-516005, (A.P.)

POSTER



K.S.R.M. COLLEGE OF ENGINEERING

(UGC - Autonomous)

Kadapa, Andhra Pradesh, India- 516 003

Approved by AICTE, New Delhi & Affiliated to JNTUA, Ananthapuramu.



KSNR
lives on.

DEPARTMENT OF CSE

ONE WEEK WORKSHOP ON

" Game Design Using BuildBox "

Organized by



SKILL DEVELOPMENT CELL,

KSRMCE IN ASSOCIATION WITH CSE & APSSDC



**4-7-2022 to
8-7-2022**



**PG-114
(INNOVATION LAB)**

Coordinator

S.RIYAZBANU

Resource Person

**Mr.C. Sathish Kumar,
APSSDC Mentor**

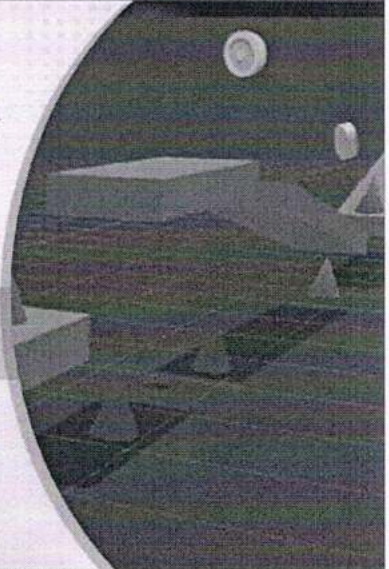

Dr. V. Lokeswara Reddy
(HOD)

Dr. V.S.S. Murthy
(Principal)

Dr. Kandula Chandra Obul Reddy
(MD, KGI)

Smt. K.Rajeswari
(Correspondent Secretary, Treasurer)

Sri K. Madan Mohan Reddy
(Vice - Chairman)

Sri K. Raja Mohan Reddy
(Chairman)

f @ > ksmceofficial

www.ksrmce.ac.in

8143731980, 8575697569



K.S.R.M. COLLEGE OF ENGINEERING

(UGC-AUTONOMOUS)

Kadapa, Andhra Pradesh, India- 516 003

Approved by AICTE, New Delhi & Affiliated to JNTUA, Ananthapuramu.

An ISO 14001:2004 & 9001: 2015 Certified Institution



SKILL DEVELOPMENT CELL

Attendance sheet of One Week Workshop on "Game Design using Build Box" from 04/07/2022 to 08/07/2022

Sl. No.	Roll No.	Name	04/7	05/7	06/7	07/7	08/7
1	219Y1A0519	C. PADMAJA	C. Padmaja	C. Padmaja	C. Padmaja	C. Padmaja	C. Padmaja
2	219Y1A0537	D. V. PRUDVI RAJ ARYAN	V. Prudvi	V. Prudvi	V. Prudvi	V. Prudvi	V. Prudvi
3	219Y1A0540	D. HARIKA	D. Harika	D. Harika	D. Harika	D. Harika	D. Harika
4	219Y1A0542	D. SUMANTH	D. Sumanth	D. Sumanth	D. Sumanth	D. Sumanth	D. Sumanth
5	219Y1A0550	G. SRAVANI	G. Sravani	G. Sravani	G. Sravani	G. Sravani	G. Sravani
6	219Y1A0552	G. SOWMYA	G. Sowmya	G. Sowmya	G. Sowmya	G. Sowmya	G. Sowmya
7	219Y1A0557	G. HARSHITH SAI	G. Harshith Sai	G. Harshith Sai	G. Harshith Sai	G. Harshith Sai	G. Harshith Sai
8	219Y1A0566	J. BHASKAR	J. Bhaskar	J. Bhaskar	J. Bhaskar	J. Bhaskar	J. Bhaskar
9	219Y1A0568	K. RAJ KUMAR	K. Raj Kumar	K. Raj Kumar	K. Raj Kumar	K. Raj Kumar	K. Raj Kumar
10	219Y1A0571	K. MADHAVI	K. Madhavi	K. Madhavi	K. Madhavi	K. Madhavi	K. Madhavi
11	219Y1A0581	K. KUSUMA	K. Kusuma	K. Kusuma	K. Kusuma	K. Kusuma	K. Kusuma
12	219Y1A0583	K. KARTHICKEYA	K. Karthickeya	K. Karthickeya	K. Karthickeya	K. Karthickeya	K. Karthickeya
13	219Y1A0587	K. IBRAHIM	K. Ibrahim	K. Ibrahim	K. Ibrahim	K. Ibrahim	K. Ibrahim
14	219Y1A0592	K. SIVA NANDHINI	K. Siva Nandhini	K. Siva Nandhini	K. Siva Nandhini	K. Siva Nandhini	K. Siva Nandhini
15	219Y1A0594	M. NAGA SANTHOSH	M. N. Santhosh	M. N. Santhosh	M. N. Santhosh	M. N. Santhosh	M. N. Santhosh
16	219Y1A0595	M. ANUSHA	M. Anusha	M. Anusha	M. Anusha	M. Anusha	M. Anusha
17	219Y1A0596	M. APARNA	M. Aparna	M. Aparna	M. Aparna	M. Aparna	M. Aparna

18	219Y1A05A2	M. VENKATA SAI NIKHIL	M. Venkata	M. Venkata	M. Venkata	M. Venkata	Venkata
19	219Y1A05A7	M. LAKSHMI BHAVANI	M. Bhavani	M. Bhavani	M. bhavani	M. bhavani	M. bhavani
20	219Y1A05A8	M. ASIF	M. ASIF	M. ASIF	m. ASif	m. ASif	M. ASif
21	219Y1A05A9	M. VINILA	M. Vinila	M. Vinila	M. Vinila	M. Vinila	M. Vinila
22	219Y1A05B5	M. SHASHA VALI	M. Shashi	M. Shashi	M. Shashi	M. Shashi	M. Shashi
23	219Y1A05B7	N. RAFI	Rafi	Rafi	Rafi	Rafi	Rafi
24	219Y1A05B8	N. RIYAZ	N. Riyaz	N. Riyaz	N. Riyaz	N. Riyaz	N. Riyaz
25	219Y1A05C0	N. SASIDHAR	N. Sasidhar	N. Sasidhar	N. Sasidhar	N. Sasidhar	N. Sasidhar
26	219Y1A05C8	P. BABJAN	P. BABJAN	P. BABJAN	P. BABJAN	P. BABJAN	P. BABJAN
27	219Y1A05D1	P. SUMALATHA	P. SUMALATHA	P. SUMALATHA	P. SUMALATHA	P. SUMALATHA	P. SUMALATHA
28	219Y1A05D4	P. SAI KRISHNA	P. S. Krishna	P. S. Krishna	P. S. Krishna	P. S. Krishna	P. S. Krishna
29	219Y1A05E1	P. SEERISHA	P. Seerisha	P. Seerisha	P. Seerisha	P. Seerisha	P. Seerisha
30	219Y1A05E4	R. ABHINASH	R. Abhinash	R. Abhinash	R. Abhinash	R. Abhinash	R. Abhinash
31	219Y1A05E9	S.SAI DIVYA	Divya	Divya	Divya	Divya	Divya
32	219Y1A05G7	S. SHASIKALA	S. Shashikala	S. Shashikala	S. Shashikala	S. Shashikala	S. Shashikala
33	219Y1A05G8	S. JAGADEESH	S. Jagadeesh	S. Jagadeesh	S. Jagadeesh	S. Jagadeesh	S. Jagadeesh
34	219Y1A05H3	T. JANARDHAN REDDY	T. J Reddy	T. J Reddy	T. J Reddy	T. J Reddy	T. J Reddy
35	219Y1A05H4	T. SAILAJA	Sailaja	Sailaja	Sailaja	Sailaja	Sailaja
36	219Y1A05I1	B. ALEKYA	B. Alekya	B. Alekya	B. Alekya	B. Alekya	B. Alekya
37	219Y1A05I2	V. MANASA	Manasa	Manasa	Manasa	Manasa	Manasa
38	219Y1A05I3	B. PRADEEP REDDY	B. P Reddy	B. P Reddy	B. P Reddy	B. P Reddy	B. P. Reddy
39	219Y1A05I4	V. SREELAKSHMI	V. Sreelakshmi	V. Sreelakshmi	V. Sreelakshmi	V. Sreelakshmi	V. Sreelakshmi
40	219Y1A05I5	V. RAJESWARI	V. R. Rajeswari	V. R. Rajeswari	V. R. Rajeswari	V. R. Rajeswari	V. R. Rajeswari
41	219Y1A05I7	V. RAVI KUMAR	V. Ravi	V. Ravi	V. Ravi	V. Ravi	V. Ravi
42	219Y1A05I8	V. POOJITHA	V. Poojitha	V. Poojitha	V. Poojitha	V. Poojitha	V. Poojitha
43	219Y1A05J3	Y. SUMALATHA	Y. Sumalatha	Y. Sumalatha	Y. Sumalatha	Y. Sumalatha	Y. Sumalatha
44	219Y1A05J6	Y. RAJA KUMAR REDDY	Y. R Reddy	Y. R Reddy	Y. R Reddy	Y. R Reddy	Y. R Reddy

[Signature]
Coordinator

V. S. S. M. W. 14
Principal
PRINCIPAL
K.S.R.M. COLLEGE OF ENGINEERING
KADAPA-516005, (A.P.)



K.S.R.M. COLLEGE OF ENGINEERING

(UGC-AUTONOMOUS)

Kadapa, Andhra Pradesh, India- 516 003

Approved by AICTE, New Delhi & Affiliated to JNTUA, Ananthapuramu.

An ISO 14001:2004 & 9001: 2015 Certified Institution



One week workshop on “Game Design using Build box”

04-July-2022 To 08-July-2022

Feedback responses

S.No.	Roll No	Year & Semester	Branch	Is the course content met your expectation	Is the lecture sequence well planned	The contents of the course is explained with examples	Is the level of course high	Is the course exposed you to the new knowledge and practices	Is the lecturer clear and easy to understand	Rate the value of course in increasing your skills	Any issues
1	219Y1A0519	B.Tech II sem	CSE	Yes	Yes	Strongly agree	Agree	Strongly agree	2	5	Nothing
2	219Y1A0537	B.Tech II sem	CSE	Yes	Yes	agree	Agree	Strongly agree	2	5	very good
3	219Y1A0540	B.Tech II sem	CSE	Yes	Yes	agree	Agree	Strongly agree	4	5	very good
4	219Y1A0542	B.Tech II sem	CSE	Yes	Yes	Strongly agree	Agree	Strongly agree	5	5	very good
5	219Y1A0519	B.Tech II sem	CSE	Yes	Yes	Strongly agree	Agree	Strongly agree	4	5	nothing
6	219Y1A0550	B.Tech II sem	CSE	Yes	Yes	agree	Agree	Strongly agree	4	5	Good
7	219Y1A0552	B.Tech II sem	CSE	Yes	Yes	agree	Agree	Strongly agree	4	5	Good
8	219Y1A0557	B.Tech II sem	CSE	Yes	Yes	agree	Agree	Strongly agree	4	5	nothing
9	219Y1A0566	B.Tech II sem	CSE	Yes	Yes	agree	Agree	Strongly agree	4	5	nothing
10	219Y1A0568	B.Tech II sem	CSE	Yes	Yes	agree	Agree	Strongly agree	4	5	nothing
11	219Y1A0571	B.Tech II sem	CSE	Yes	Yes	agree	Agree	Strongly agree	4	5	Good
12	219Y1A0581	B.Tech II sem	CSE	Yes	Yes	agree	Agree	Strongly agree	5	5	Good
13	219Y1A0583	B.Tech II sem	CSE	Yes	Yes	agree	Agree	Strongly agree	5	5	very good

14	219Y1A0587	B.Tech II sem	CSE	Yes	Yes	Strongly agree	Agree	Strongly agree	5	5	very good
15	219Y1A0592	B.Tech II sem	CSE	Yes	Yes	Strongly agree	Agree	Strongly agree	5	5	nothing
16	219Y1A0594	B.Tech II sem	CSE	Yes	Yes	agree	Agree	Strongly agree	4	4	very good
17	219Y1A0595	B.Tech II sem	CSE	Yes	Yes	agree	Agree	Strongly agree	3	5	no
18	219Y1A0596	B.Tech II sem	CSE	Yes	Yes	agree	Agree	Strongly agree	4	5	nithing
19	219Y1A05A2	B.Tech II sem	CSE	Yes	Yes	Strongly agree	Agree	Strongly agree	5	5	Good
20	219Y1A05A7	B.Tech II sem	CSE	Yes	Yes	Strongly agree	Agree	Strongly agree	3	4	Good
21	219Y1A05A8	B.Tech II sem	CSE	Yes	Yes	Strongly agree	Agree	Strongly agree	5	3	Good
22	219Y1A05A9	B.Tech II sem	CSE	Yes	Yes	agree	Agree	Strongly agree	4	4	Good
23	219Y1A05B5	B.Tech II sem	CSE	Yes	Yes	agree	Agree	Strongly agree	3	4	Good
24	219Y1A05B8	B.Tech II sem	CSE	Yes	Yes	Strongly agree	Agree	Strongly agree	5	4	Good
25	219Y1A05C0	B.Tech II sem	CSE	Yes	Yes	agree	Agree	Strongly agree	3	5	Good
26	219Y1A05C8	B.Tech II sem	CSE	Yes	Yes	agree	Agree	Strongly agree	5	5	Nothing
27	219Y1A05D1	B.Tech II sem	CSE	Yes	Yes	agree	Agree	Strongly agree	5	5	no
28	219Y1A05D4	B.Tech II sem	CSE	Yes	Yes	agree	Agree	Strongly agree	3	4	no
29	219Y1A05E1	B.Tech II sem	CSE	Yes	Yes	Strongly agree	Agree	Strongly agree	3	4	no
30	219Y1A05E4	B.Tech II sem	CSE	Yes	Yes	Strongly agree	Agree	Strongly agree		5	no
31	219Y1A05E9	B.Tech II sem	CSE	Yes	Yes	Strongly agree	Agree	Strongly agree	5	4	nothing
32	219Y1A05G7	B.Tech II sem	CSE	Yes	Yes	agree	Agree	Strongly agree	5	5	Nothing
33	219Y1A05G8	B.Tech II sem	CSE	Yes	Yes	agree	Agree	Strongly agree	5	4	no
34	219Y1A05H3	B.Tech II sem	CSE	Yes	Yes	agree	Agree	Strongly agree	5	4	Nothing
35	219Y1A05H4	B.Tech II sem	CSE	Yes	Yes	agree	Agree	Strongly agree	5	4	Good
36	219Y1A05I1	B.Tech II sem	CSE	Yes	Yes	agree	Agree	Strongly agree	5	5	Good
37	219Y1A05I2	B.Tech II sem	CSE	Yes	Yes	agree	Agree	Strongly agree	5	5	Good
38	219Y1A05I3	B.Tech II sem	CSE	Yes	Yes	Strongly agree	Agree	Strongly agree	5	5	Good
39	219Y1A05I4	B.Tech II sem	CSE	Yes	Yes	Strongly agree	Agree	Strongly agree	5	5	Good
40	219Y1A05I5	B.Tech II sem	CSE	Yes	Yes	Strongly agree	Agree	Strongly agree	5	5	Good
41	219Y1A05I7	B.Tech II sem	CSE	Yes	Yes	agree	Agree	Strongly agree	4	4	Good
42	219Y1A05I8	B.Tech II sem	CSE	Yes	Yes	agree	Agree	Strongly agree	4	5	Good
43	219Y1A05J3	B.Tech II sem	CSE	Yes	Yes	agree	Agree	Strongly agree	4	5	Good
44	219Y1A05J6	B.Tech II sem	CSE	Yes	Yes	agree	Agree	Strongly agree	3	5	Good



Andhra Pradesh State Skill Development Corporation (APSSDC)

(Department of Skills Development & Training, Govt. of Andhra Pradesh)



Certificate of Participation



Cert.No. BB/STP/22-23/089

Regd Id : 219Y1A0514

This is to certify that Mr./Ms./Mrs.....Bonala Venkateswarlu.....
ofKSRM College Of Engineering..... has successfully
participated Online Training Program onGame Design Using Buildbox Offline.....
held from18-07-2022.....to23-07-2022.....

V. S. S. Murthy
Principal (or) HOD

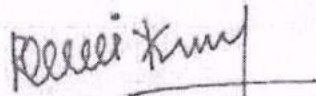
Dr. Ravi K Gujjula
Chief General Manager (Technical)
APSSDC

Sri S. Satyanarayana, IAS
Managing Director
APSSDC



Andhra Pradesh State Skill Development Corporation (APSSDC)

(Department of Skills Development & Training, Govt. of Andhra Pradesh)



Skill AP
APSSDC

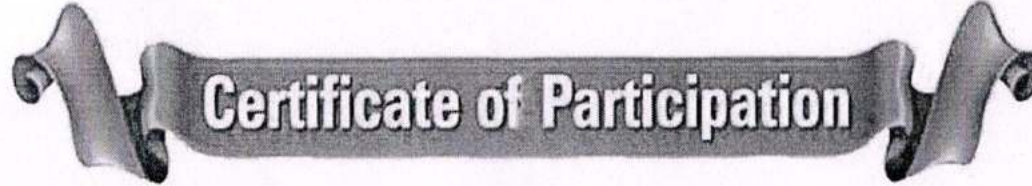

Certificate of Participation



Cert.No. BB/STP/22-23/091

Regd Id : 219Y1A0517

This is to certify that Mr./Ms./Mrs.....Byreddy.Gowthami.....
ofKSRM College Of Engineering..... has successfully
participated Online Training Program onGame Design Using Buildbox Offline.....
held from18-07-2022..... to23-07-2022.....

V. S. S. m n 14

Principal (or) HOD

Dr. Ravi K Gujjula

Dr. Ravi K Gujjula
Chief General Manager (Technical)
APSSDC

Sri S. Satyanarayana

Sri S. Satyanarayana, IAS
Managing Director
APSSDC



Andhra Pradesh State Skill Development Corporation (APSSDC)

(Department of Skills Development & Training, Govt. of Andhra Pradesh)



Skill AP
APSSDC

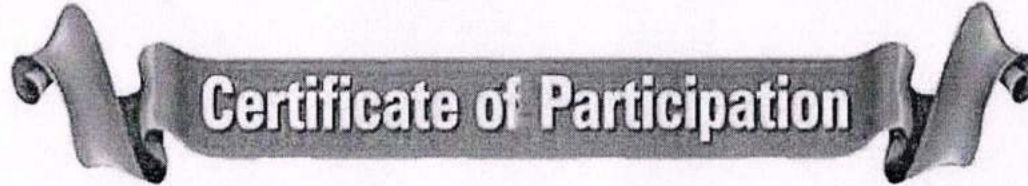

Certificate of Participation



Cert.No. BB/STP/22-23/093

Regd Id : 219Y1A0523

This is to certify that Mr./Ms./Mrs.....C.Devendra Prasad.....
ofKSRM College Of Engineering..... has successfully
participated Online Training Program on Game Design Using Buildbox Offline.....
held from18-07-2022.....to23-07-2022.....

V. S. S. Murthy

Principal (or) HOD

Dr. Ravi K Gujjula

Chief General Manager (Technical)

APSSDC

Sri S. Satyanarayana, IAS

Managing Director

APSSDC



K.S.R.M. COLLEGE OF ENGINEERING

(UGC - AUTONOMOUS)

Kadapa, Andhra Pradesh, India - 516003

Approved by AICTE, New Delhi & Affiliated to JNTUA, Ananthapuramu.

An ISO 14001:2004 & 9001: 2015 Certified Institution



Lr./KSRMCE/ (Department of ECE)/2022-23

Date: 30-06-2022

To
The Principal
KSRM College of Engineering
Kadapa, AP.

Sub: KSRMCE - (Department of ECE) – Permission to conduct Workshop on “FPGA Implementation of Digital Circuits using Vivado” –Request– reg.

---***---

Respected Sir,

With reference to the cited, the Department of ECE in KSRMCE is going to organize a workshop for B.Tech E.C.E students at DSP Lab from 04/07/2022 to 5/07/2022 in SJ Block. In this connection I kindly request you to give us permission to organize the Workshop successfully.

Thanking you sir,

Yours Faithfully,

Smt. S. Sharmila Banu

Miss P. Swetha
Coordinators

Cc:

IQAC

KSRMCE

Permitted
V. S. S. Mm/K
PRINCIPAL
K.S.R.M. COLLEGE OF ENGINEERING
KADAPA-516005, (A.P.)

 /kasmce.ac.in

Follow Us:



/kasmceofficial

K.S.R.M. COLLEGE OF ENGINEERING

(UGC - AUTONOMOUS)

Kadapa, Andhra Pradesh, India - 516003



Approved by AICTE, New Delhi & Affiliated to JNTUA, Ananthapuramu.

An ISO 14001:2004 & 9001: 2015 Certified Institution



Cr./KSRMCE/ (Department of ECE)/2022-23

Date: 30-06-2022

Circular

All the B.Tech ECE students are hereby informed that the department of ECE is going to conduct a Workshop on "FPGA Implementation of Digital Circuits using Vivado" from 04-07-2022 to 05-07-2022. Interested students may register their names with the following link on or before 02-07-2022.

Registration Link: <https://forms.gle/FA9gppJC5KmDHUQs7>

For any queries contact,

Coordinators
Smt. S. Sharmila Banu
Miss P. Swetha



HEAD OF THE DEPARTMENT

Professor & H.O.D.
Department of E.C.E.
K.S.R.M. College of Engineering
KADAPA - 516 003

Cc to:

IQAC

KSRMCE

 /krmce.ac.in

Follow Us:



/krmceofficial



K.S.R.M. COLLEGE OF ENGINEERING

(UGC - Autonomous)

Kadapa, Andhra Pradesh, India- 516 003

Approved by AICTE, New Delhi & Affiliated to JNTUA, Ananthapuramu.



DEPARTMENT OF ECE



A Two - Day Workshop on "FPGA Implementation of Digital circuits using Vivado"

in Association with IETE-ISF & IEEE SB



4th & 5th
July 2022



DSP Lab

Coordinators

Smt. S. Sharmila Banu,
Asst. Prof, Department of ECE

Miss P. Swetha,
Asst. Prof, Department of ECE

Resource Persons

Miss S. Jabeen,
Asst. Prof, Department of ECE

Smt. K. Divya Lakshmi,
Asst. Prof, Department of ECE

Dr. G. Hemalatha
(Vice-Chancellor)

Dr. Y.S.S. Murthy
(Principal)

Dr. Kandula Chandra Obul Reddy
(Managing Director)

Smt. K. Rajeswari
(Correspondent Secretary, Treasurer)

Sri K. Madan Mohan Reddy
(Vice - Chairman)

Sri K. Raja Mohan Reddy
(Chairman)

[kasmceofficial](#)

www.kasmce.ac.in

8143731980, 8575697569



K.S.R.M. COLLEGE OF ENGINEERING

(UGC-AUTONOMOUS)

Kadapa, Andhra Pradesh, India- 516 003

Approved by AICTE, New Delhi & Affiliated to JNTUA, Ananthapuramu.

An ISO 14001:2004 & 9001: 2015 Certified Institution

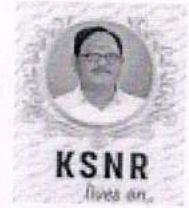

ACTIVITY REPORT

Workshop
On

“FPGA implementation of digital circuits using vivado”

4th July 2022 to 5th July 2022

Target Group	:	Students
Details of Participants	:	26 Students
Coordinators	:	Smt. S. Sharmila Banu, Asst. Prof, Dept. of ECE Miss P. Swetha, Asst. Prof, Dept. of ECE
Organizing Department	:	Department of Electronics and Communication Engineering
Venue	:	Dsp lab

Description:

Workshop on “FPGA implementation of digital circuits using vivado” was organized by Dept. of ECE from 04-07-2022 to 05-07-2022. Miss S. Jabeen, Smt. K. Divyalakshmi acted as Course instructors. Basics and design flow of Verilog HDL, Models of Verilog HDL, FPGA implementation of combinational and sequential circuits using vivado were explained.

Photos:

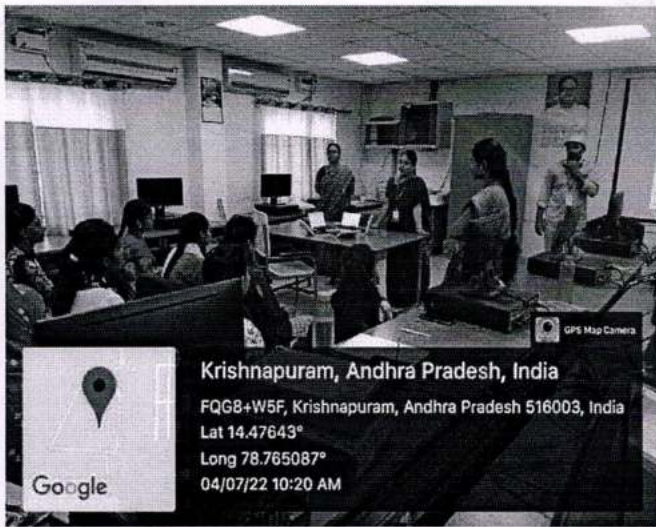

Fig: HOD addressing the participants

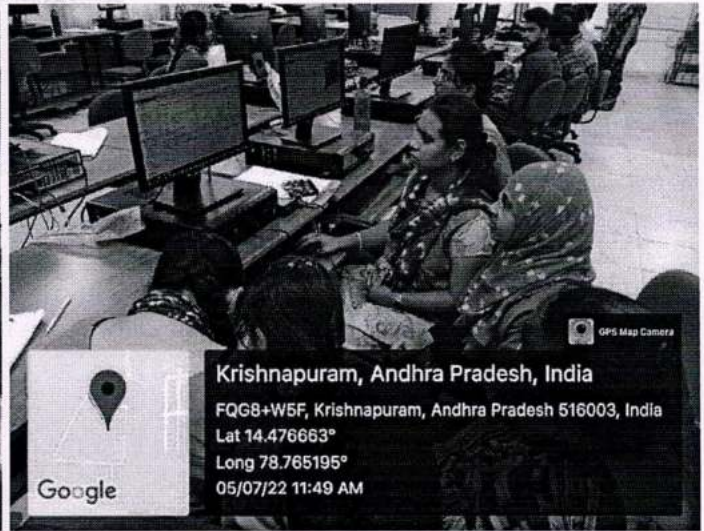

Fig: Hands-on Session by the students

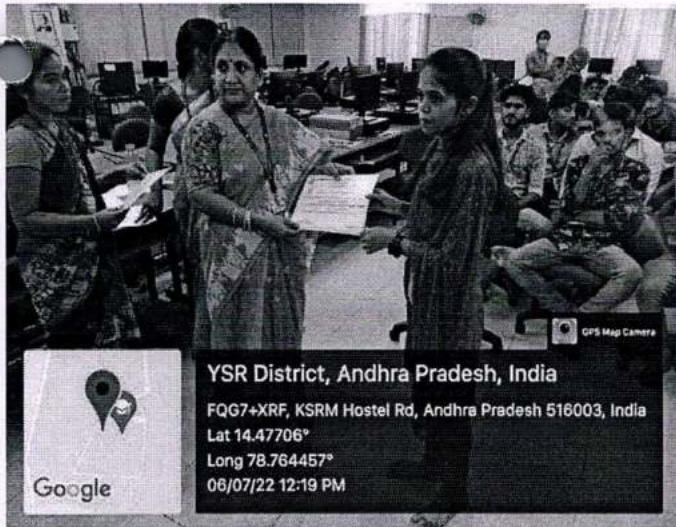

Fig: Certificate distribution & Group photo

[Handwritten Signature]
Coordinator

[Handwritten Signature]
HOD
Professor & H.O.D.
Department of E.C.E.
K.S.R.M. College of Engineering
KADAPA - 516 093.



K.S.R.M. COLLEGE OF ENGINEERING (UGC-AUTONOMOUS)

Kadapa, Andhra Pradesh, India- 516 003

Approved by AICTE, New Delhi & Affiliated to JNTUA, Ananthapuramu.
An ISO 14001:2004 & 9001: 2015 Certified Institution



Date: 04-07-2022

Name of the Event: Two-day Workshop on "FPGA Implementation of Digital Circuits using Vivado"

Venue : DSP lab

List of Participants

S. No	Name	Roll No	Contact No./Email Id	Signature
1	B. Viharika	209Y1A0413	209Y1A0413@ksrmce.ac.in	
2	N. Harathi	209Y1A04A3	209Y1A04A3@ksrmce.ac.in	
3	C. Rowthia yadav	209Y1A04086	209Y1A04086@ksrmce.ac.in	
4	E. Nithya sree	209Y1A0447	209Y1A0447@ksrmce.ac.in	
5	G. Swetha	209Y1A0451	209Y1A0451@ksrmce.ac.in	
6	D. Swetha	209Y1A0441	209Y1A0441@ksrmce.ac.in	
7	B. Kalyani	209Y1A0409	209Y1A0409@ksrmce.ac.in	
8	B. Anusha	209Y1A0408	209Y1A0408@ksrmce.ac.in	
9	Madhavi. C	209Y1A0430	209Y1A0430@ksrmce.ac.in	
10	S. Beebi Ayesha Siddika	209Y1A0405	209Y1A0405@ksrmce.ac.in	
11	B. Parimala	219Y5A0403	219Y5A0403@ksrmce.ac.in	
12	B. Bharath reddy	209Y1A0410	209Y1A0410@ksrmce.ac.in	
13	G. Nagesh Babu	209Y1A0453	209Y1A0453@ksrmce.ac.in	
14	V. Arun Kumar	209Y1A04F0	209Y1A04F0@ksrmce.ac.in	
15	M. Vishnu Vardhan Reddy	209Y1A0484	209Y1A0484@ksrmce.ac.in	
16	O. Praveen Kumar	209Y1A04A4	209Y1A04A4@ksrmce.ac.in	
17	N. Vasanth Kumar Reddy	209Y1A0498	209Y1A0498@ksrmce.ac.in	
18	M. Rajiv	209Y1A0493	209Y1A0493@ksrmce.ac.in	
19	B. Ravikanth	209Y1A0414	209Y1A0414@ksrmce.ac.in	

20	Sare Arun Kumar	219Y5A0415	219Y5A0415@krmce.ac.in	S. Arun Kumar
21	C. Rajasekharaiah	209Y1A0431	209Y1A0431@krmce.ac.in	C. Reddy
22	Y. Maheswar Reddy	209Y1A04F8	209Y1A04F8@krmce.ac.in	Y. Mahi
23	C. Rajeshwar Reddy	209Y1A0427	209Y1A0427@krmce.ac.in	C. Rajeshwar
24	B. Navesh	209Y1A0412	209Y1A0412@krmce.ac.in	B. Navesh
25	C. Karthik Reddy	209Y1A0429	209Y1A0429@krmce.ac.in	C. Karthik
26	S. Sumanth Reddy	209Y1A04D6	209Y1A04D6@krmce.ac.in	S. Sumanth
27				
28				
29				
30				

S. Sumanth
Co-ordinator
P.S.

V. S. S. M. M. 15
Principal

PRINCIPAL
K.S.R.M. COLLEGE OF ENGINEERING
KADAPA-516005, (A.P.)



K.S.R.M. COLLEGE OF ENGINEERING (UGC-AUTONOMOUS)

Kadapa, Andhra Pradesh, India- 516 003
Approved by AICTE, New Delhi & Affiliated to JNTUA, Ananthapuramu.
An ISO 14001:2004 & 9001: 2015 Certified Institution



Date: 05-07-2022

Name of the Event: Two-day Workshop on "FPGA Implementation of Digital Circuits using Vivado"

Venue : DSP lab

List of Participants

S. No	Name	Roll No	Contact No./Email Id	Signature
1	O. Praveen Kumar	209Y1A04A4	209Y1A04A4@ksrmce.ac.in	<i>Praveen Kumar</i>
2	M. Kajiv	209Y1A0493	209Y1A0493@ksrmce.ac.in	<i>M. Kajiv</i>
3	Y. Maheswar Reddy	209Y1A04F8	209Y1A04F8@ksrmce.ac.in	<i>Y. Maheswar Reddy</i>
4	B. Bhagath Simha Reddy	209Y1A0410	209Y1A0410@ksrmce.ac.in	<i>B. Bhagath Simha Reddy</i>
5	C. Rajasekhara Reddy	209Y1A0431	209Y1A0431@ksrmce.ac.in	<i>C. Rajasekhara Reddy</i>
6	G. Jagannatha Prasad	209Y1A0453	209Y1A0453@ksrmce.ac.in	<i>G. Jagannatha Prasad</i>
7	C. Rohitha	209Y1A0426	209Y1A0426@ksrmce.ac.in	<i>C. Rohitha</i>
8	B. Anusha	209Y1A0408	209Y1A0408@ksrmce.ac.in	<i>B. Anusha</i>
9	Madhavi. C	209Y1A0430	209Y1A0430@ksrmce.ac.in	<i>Madhavi. C</i>
10	Swathi. D	209Y1A0441	209Y1A0441@ksrmce.ac.in	<i>Swathi. D</i>
11	B. Viharika	209Y1A0413	209Y1A0413@ksrmce.ac.in	<i>B. Viharika</i>
12	B. Kalyani	209Y1A0409	209Y1A0409@ksrmce.ac.in	<i>B. Kalyani</i>
13	G. Swetha	209Y1A0465	209Y1A0465@ksrmce.ac.in	<i>G. Swetha</i>
14	E. Nithya Sree	209Y1A0467	209Y1A0467@ksrmce.ac.in	<i>E. Nithya Sree</i>
15	S. Beebi Ayesha Siddika	209Y1A0415	209Y1A0415@ksrmce.ac.in	<i>S. Beebi Ayesha Siddika</i>
16	N. Vasanth Kumar Reddy	209Y1A0498	209Y1A0498@ksrmce.ac.in	<i>N. Vasanth Kumar Reddy</i>
17	B. Nareesh	209Y1A0412	209Y1A0412@ksrmce.ac.in	<i>B. Nareesh</i>
18	C. Karthik Reddy	209Y1A0429	209Y1A0429@ksrmce.ac.in	<i>C. Karthik Reddy</i>
19	B. Ravi Kant Reddy	209Y1A0444	209Y1A0444@ksrmce.ac.in	<i>B. Ravi Kant Reddy</i>

20	V. Arun Kumar	20941A04FC	20941A04FC@ksrmce.ac.in	Arun
21	M. Vishnu Varadhan Reddy	20941A048H	20941A048H@ksrmce.ac.in	M. Vishnu Varadhan Reddy
22	Sare Arun Kumar	21945A041F	21945A041F@ksrmce.ac.in	Sare Arun Kumar
23	C. Rajeshwar Reddy	20941A0427	20941A0427@ksrmce.ac.in	C. Rajeshwar Reddy
24	N. Harjathie	20941A04A3	20941A04A3@ksrmce.ac.in	N. Harjathie
25	B. Basimala	21945A0403	21945A0403@ksrmce.ac.in	B. Basimala
26	S. Sumanth Reddy	20941A0406	20941A0406@ksrmce.ac.in	S. Sumanth Reddy
27				
28				
29				
30				

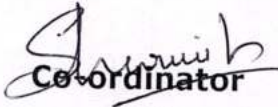
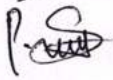
 Co-ordinator

V. S. S. Mmlg
 Principal
 PRINCIPAL
 K.S.R.M. COLLEGE OF ENGINEERING
 KADAPA-516005, (A.P.)



K.S.R.M. COLLEGE OF ENGINEERING

(UGC - AUTONOMOUS)

Kadapa, Andhra Pradesh, India - 516003

Approved by AICTE, New Delhi & Affiliated to JNTUA, Ananthapuramu.

Department of Electronics and Communication Engineering

Feedback Form

S.No.	Email address	Name of the student	Year & Semester	Branch	Roll Num	Is the course content met your expectation	Is the lecture sequence well planned	The contents of the course is explained with examples	Is the level of course high	Is the course exposed you to the new knowledge and practices	Is the lecture clear and easy to understand	Rate the value of course in increasing your skills	Any issues
1	209Y1A0427@ksrmce.ac.in	RAJESHWAR A REDDY	B.Tech IVsem	ECE	209Y1A0427	Yes	Yes	Agree	Agree	Strongly agree	4	5	Nothing
2	209Y5A0415@ksrmce.ac.in	S. ARUN KUMAR	B.Tech IVsem	ECE	219Y5A0415	Yes	Yes	Agree	Agree	Strongly agree	5	5	Nothing
3	209Y1A0429@ksrmce.ac.in	C. KARTHIK REDDY	B.Tech IVsem	ECE	209Y1A0429	Yes	Yes	Agree	Agree	Strongly agree	4	5	Good
4	209Y1A0412@ksrmce.ac.in	B. NARESH	B.Tech IVsem	ECE	209Y1A0412	Yes	Yes	Agree	Agree	Strongly agree	5	5	nothing
5	209Y1A04F8@ksrmce.ac.in	MAHESWAR REDDY	B.Tech IVsem	ECE	209Y1A04F8	Yes	Yes	Agree	Agree	Strongly agree	5	5	Good
6	209Y1A0413@ksrmce.ac.in	B. VIHARIKA	B.Tech IVsem	ECE	209Y1A0413	Yes	Yes	Agree	Agree	Strongly agree	4	5	very good
7	209Y1A0447@ksrmce.ac.in	E. NITHYASREE	B.Tech IVsem	ECE	209Y1A0447	Yes	Yes	Strongly agree	Agree	Strongly agree	4	3	Nothing

8	209Y1A04C5@ksrmce.ac.in	AYESHA SIDDIKA	B.Tech IVsem	ECE	209Y1A04C5	Yes	Yes	agree	Agree	Strongly agree	4	4	no
9	209Y1A04A3@ksrmce.ac.in	N. HARATHI	B.Tech IVsem	ECE	209Y1A04A3	Yes	Yes	Strongly agree	Agree	Strongly agree	5	5	Nothing
10	209Y1A0409@ksrmce.ac.in	B. KALYANI	B.Tech IVsem	ECE	209Y1A0409	Yes	Yes	Strongly agree	Agree	Strongly agree	5	5	Good
11	209Y1A0451@ksrmce.ac.in	G. SWETHA	B.Tech IVsem	ECE	209Y1A0451	Yes	Yes	Agree	Agree	Strongly agree	5	4	Good
12	209Y1A0410@ksrmce.ac.in	SIMHA REDDY	B.Tech IVsem	ECE	209Y1A0410	Yes	Yes	agree	Agree	Strongly agree	5	5	Good
13	209Y1A04A4@ksrmce.ac.in	O. PRAVEEN KUMAR	B.Tech IVsem	ECE	209Y1A04A4	Yes	Yes	agree	Agree	Strongly agree	3	5	Good
14	209Y1A0431@ksrmce.ac.in	RAJASEKHAR NAIDU	B.Tech IVsem	ECE	209Y1A0431	Yes	Yes	agree	Agree	Strongly agree	5	4	very good
15	209Y1A0441@ksrmce.ac.in	D. SWETHA	B.Tech IVsem	ECE	209Y1A0441	Yes	Yes	agree	Agree	Strongly agree	4	4	very good
16	209Y1A0408@ksrmce.ac.in	B. ANUSHA	B.Tech IVsem	ECE	209Y1A0408	Yes	Yes	agree	Agree	Strongly agree	5	4	very good
17	209Y1A0430@ksrmce.ac.in	C. MADHAVI	B.Tech IVsem	ECE	209Y1A0430	Yes	Yes	agree	Agree	Strongly agree	3	5	no
18	219Y5A0403@ksrmce.ac.in	B. PARIMALA	B.Tech IVsem	ECE	219Y5A0403	Yes	Yes	agree	Agree	Strongly agree	4	5	nithing
19	209Y1A0453@ksrmce.ac.in	NAGENDRAP RASAD	B.Tech IVsem	ECE	209Y1A0453	Yes	Yes	Strongly agree	Agree	Strongly agree	4	5	Good
20	209Y1A0414@ksrmce.ac.in	RAVIKANTH REDDY	B.Tech IVsem	ECE	209Y1A0414	Yes	Yes	Strongly agree	Agree	Strongly agree	4	4	Good
21	209Y1A04F0@ksrmce.ac.in	V. ARUN KUMAR	B.Tech IVsem	ECE	209Y1A04F0	Yes	Yes	Strongly agree	Agree	Strongly agree	4	3	Good
22	209Y1A0484@ksrmce.ac.in	VARDHAN REDDY	B.Tech IVsem	ECE	209Y1A0484	Yes	Yes	agree	Agree	Strongly agree	4	4	Good
23	209Y1A0426@ksrmce.ac.in	C. ROHITHA YADAV	B.Tech IVsem	ECE	209Y1A0426	Yes	Yes	agree	Agree	Strongly agree	5	4	Good

24	209Y1A0498@ksrmce.ac.in	KUMAR REDDY	B.Tech IVsem	ECE	209Y1A0498	Yes	Yes	Strongly agree	Agree	Strongly agree	5	4	Good
25	209Y1A04D6@ksrmce.ac.in	S. SUMANTH REDDY	B.Tech IVsem	ECE	209Y1A04D6	Yes	Yes	agree	Agree	Strongly agree	5	5	Good
26	209Y1A0493@ksrmce.ac.in	M. RAJU	B.Tech IVsem	ECE	209Y1A0493	Yes	Yes	agree	Agree	Strongly agree	5	5	Nothing

Coordinator

P. S.
[Signature]

G. H. B.
HOD

Professor & H.O.D.
Department of E.C.E.
K.S.R.M. College of Engineering
KADAPA - 516 003.

V. S. S. Mmly

PRINCIPAL

K.S.R.M. COLLEGE OF ENGINEERING
KADAPA-516005, (A.P.)



K.S.R.M. COLLEGE OF ENGINEERING (AUTONOMOUS)

(Approved by AICTE, Accredited by NAAC & UGC, Affiliated to JNTUA, Ananthapuramu)
(An ISO 9001:2015 Certified Institution)
Kadapa - 516003, Andhra Pradesh, India

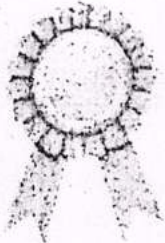

CERTIFICATE OF PARTICIPATION

This is to certify that *O. Praveen Kumar* Of *K.S.R.M.C.E.*

has participated in A Two-Day Workshop

“FPGA IMPLEMENTATION OF DIGITAL CIRCUITS USING VIVADO”

held on 4th -5th July, 2022, Organized by the

Department of E.C.E in association with IEEE SB & IETE ISF.

Dr. G. Hemalatha
Head of the department

Dr. V.S.S. Murthy
Principal



S.R.M. COLLEGE OF ENGINEERING

(UGC-AUTONOMOUS)

Kadapa, Andhra Pradesh, India- 516 003

Approved by AICTE, New Delhi & Affiliated to JNTUA, Ananthapuramu.

An ISO 14001:2004 & 9001: 2015 Certified Institution

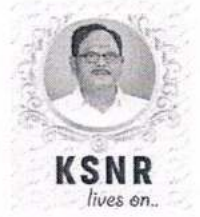

Lr./KSRMCE/CSE/Workshop/2022

Date: 20.07.2022.

To
The Principal,
K.S.R.M College of Engineering
Kadapa.

From
Dr.V. Lokeswara Reddy,
Professor & Head,
CSE Department,
K.S.R.M College of Engineering
Kadapa.

Respected Sir,

Sub: KSRMCE- Requisition to give permission for organizing workshop-reg.

On behalf of Department of Computer Science and Engineering, we would like to conduct a workshop on "**How to Prepare to Get Job in Product Based Company?**" for IV Semester CSE students on 22-July-2022. In this regard, we request you give permission to organize the workshop. The resource person for the workshop shall be Dr. G. Murali, Assistant Professor, Department of CSE, JNTUACEP.

Thanking you Sir.

Yours Faithfully

Dr.V. Lokeswara Reddy

Dr. S. M. Farooq

Sri.B. Mahesh Reddy,
Coordinators
Dept. of CSE

*Forwarded to the
principal sir,*

*Permitted
U.S.S. Murali*



K.S.R.M. COLLEGE OF ENGINEERING

(UGC-AUTONOMOUS)

Kadapa, Andhra Pradesh, India- 516 003

Approved by AICTE, New Delhi & Affiliated to JNTUA, Ananthapuramu.

An ISO 14001:2004 & 9001: 2015 Certified Institution



Cr./KSRMCE/CSE/Workshop/2022-23

Date:21.07.2022.

Circular

All the II B.Tech IV semester CSE Students of KSRMCE are hereby informed that Department of CSE is going to conduct a workshop on “**How to Prepare to Get Job in Product Based Company?**”. The workshop is scheduled on 22-July-2022 at MB 301 CSE Seminar Hall. The resource person for the workshop is Dr.G.Murali, Assistant Professor, Dept. of CSE, JNTUACEP.

In this connection, Interested II B. Tech IV Semester CSE students of KSRMCE are instructed to register their names with the coordinators of the workshop.

Coordinators:

Dr. V. Lokeswara Reddy, Professor & Head, Dept. of CSE.

Dr. S.M. Farooq, Associate professor, Dept. of CSE, KSRMCE.

Sri. B. Mahesh Reddy, Assistant professor, Dept. of CSE, KSRMCE.

Cc to:

The Management / Director / All Deans/All HoDs/staff/ Students for Information

The IQAC Cell for Documentation

V. S. S. M. Reddy
Principal
K.S.R.M. COLLEGE OF ENGINEERING
KADAPA-516003. (A.P.)



/karmce.ac.in

Follow Us:



/karmceofficial



Activity Report

Name of the Activity	How to prepare to get Job in product based company?	
Type of Activity	Workshop	
Date and Time of Activity	22.07.2022	5PM to 6PM
Details of Participants	72 members	
Coordinator(s)	Dr. V. Lokeswara Reddy, Professor & Head, Dept. of CSE. Dr. S. M. Farooq, Associate Professor, Dept. of CSE. Sri. B. Mahesh Reddy, Assistant Professor, Dept. of CSE.	
Organizing Dept./Support System	Computer Science and Engineering	
Description	<p>The workshop Inaugurated by Dr. V. Lokeswara Reddy, Professor & Head, Dept. of CSE. The resource person Dr. G. Muali, Assistant Professor, Dept. of CSE, JNTUACEP enlightened the students regarding “How to prepare to get job in product based company?”. He emphasized on the importance of getting jobs in product based company for sustainable career growth. There are many platforms are available for the students to prepare and crack in product based companies. He enumerated some of the platforms to explore like www.codechef.com, leetcode.com, exercism.com, arcoder.jp etc. He urged the students to first gain confidence by preparing a proper plan to solve problems in data structures and algorithms, programming in C, Python and Java. The resource person informed to the students the growing need of skilled personnel in the latest IT technologies such as Blockchain, Computer Vision, Ethical hacking etc. The coordinators of the workshop given vote of thanks.</p>	



S.R.M. COLLEGE OF ENGINEERING

(UGC-AUTONOMOUS)

Kadapa, Andhra Pradesh, India - 516 003

Approved by AICTE, New Delhi & Affiliated to JNTUA, Ananthapuramu.

An ISO 14001:2004 & 9001: 2015 Certified Institution



Date: 22-07-2022

Name of the Event : Workshop on "How to prepare to get Job in product based companies?"

Venue : MB 301 Seminar Hall.

List of Participants

S.No	Roll Number	Name of the Student	Year & Branch	Email id	Signature
1	209Y1A0589	L.Tharun	II & CSE	209Y1A0589@kasmce.ac.in	L.Tharun
2	209Y1A0570	J. V. Sri Ram	II & CSE	209Y1A0570@kasmce.ac.in	J. V. Sri Ram
3	209Y1A0592	M. Vishnu Prabu	II & CSE	209Y1A0592@kasmce.ac.in	M. Vishnu Prabu
4	209Y1A0588	P. Venkata Manoj	II & CSE	209Y1A0588@kasmce.ac.in	P. Venkata Manoj
5	209Y1A0589	P. Sai Krishna Reddy	II & CSE	209Y1A0589@kasmce.ac.in	P. Sai Krishna Reddy
6	209Y1A0581	K.S. Fazil	II & CSE	209Y1A0581@kasmce.ac.in	K.S. Fazil
7	209Y1A0585	P. Shujath	II & CSE	209Y1A0585@kasmce.ac.in	P. Shujath
8	209Y1A0572	J. Dhery	II & CSE	209Y1A0572@kasmce.ac.in	J. Dhery
9	209Y1A0582	N. Uma Maheswari	II & CSE	209Y1A0582@kasmce.ac.in	N. Uma Maheswari
10	209Y1A0593	M. Vasavi	II & CSE	209Y1A0593@kasmce.ac.in	M. Vasavi
11	209Y1A0579	K. Jayasree	II & CSE	209Y1A0579@kasmce.ac.in	K. Jayasree
12	209Y1A0586	M. Naga Sahitya	II & CSE	209Y1A0586@kasmce.ac.in	M. Naga Sahitya
13	209Y1A0581	M. Vinay Datta Krishna Reddy	II & CSE	209Y1A0581@kasmce.ac.in	M. Vinay Datta Krishna Reddy
14	209Y1A0573	J. Ramu	II & CSE	209Y1A0573@kasmce.ac.in	J. Ramu
15	209Y1A0578	K. Harsha Nithin	II & CSE	209Y1A0578@kasmce.ac.in	K. Harsha Nithin

43	209Y1A0549	D. Sai Teja	2 nd year, CSE	209Y1A0549@krmce.ac.in	D. Sai Teja
44	209Y1A0553	D. Lakshmi Swetha	2 nd year, CSE	209Y1A0553@krmce.ac.in	D. Swetha
45	209Y1A0569	G. Deekshitha	2 nd year, CSE	209Y1A0569@krmce.ac.in	G. Deekshitha
46	209Y1A0559	G. Geetha Sri	2 nd year, CSE	209Y1A0559@krmce.ac.in	G. Geetha Sri
47	209Y1A0558	G. Yoga Lakshmi	2 nd year, CSE	209Y1A0558@krmce.ac.in	G. Yoga Lakshmi
48	209Y1A0537	C. Renu Sri	2 nd year, CSE	209Y1A0537@krmce.ac.in	C. Renu Sri
49	209Y1A0557	G. Madhavi	2 nd year, CSE	209Y1A0557@krmce.ac.in	G. Madhavi
50	209Y1A0540	C. Praveena	2 nd year, CSE	209Y1A0540@krmce.ac.in	C. Praveena
51	209Y1A0548	D. Jai Konda Rao	2 nd year, CSE	209Y1A0548@krmce.ac.in	D. Jai
52	209Y1A0562	G. Venkata Kireeti	2 nd year, CSE	209Y1A0562@krmce.ac.in	G. Venkata Kireeti
53	209Y1A0550	D. Nisanjan Reddy	2 nd year, CSE	209Y1A0550@krmce.ac.in	D. Nisanjan
54	209Y1A0560	G. Santosh	2 nd year, CSE	209Y1A0560@krmce.ac.in	G. Santosh
55	209Y1A0555	G. Vandee Karshna	2 nd year, CSE	209Y1A0555@krmce.ac.in	G. Vandee Karshna
56	209Y1A0563	G. Remytham Reddy	2 nd year, CSE	209Y1A0563@krmce.ac.in	G. Remytham Reddy
57	209Y1A0544	D. Hegeswar	2 nd year, CSE	209Y1A0544@krmce.ac.in	D. Hegeswar
58	209Y1A0568	G. Umar Farooq	2 nd year, CSE	209Y1A0568@krmce.ac.in	G. Umar Farooq
59	209Y1A0539	C. Rangarajakula	2 nd year, CSE	209Y1A0539@krmce.ac.in	C. Rangaraj
60	209Y1A0551	D. Umar Farooq	2 nd year, CSE	209Y1A0551@krmce.ac.in	D. Umar Farooq
61	209Y1A0541	C. P. Ravindra	2 nd year, CSE	209Y1A0541@krmce.ac.in	C. P. Ravindra
62	209Y1A0506	A. Gowtham Kumar	2 nd year, CSE	209Y1A0506@krmce.ac.in	A. Gowtham
63	209Y1A0520	B. Raju	2 nd year, CSE	209Y1A0520@krmce.ac.in	B. Raju
64	209Y1A0533	C. V. Ashwin Kumar	2 nd year, CSE	209Y1A0533@krmce.ac.in	Ashwin
65	209Y1A0523	B. S. Hubair	2 nd year, CSE	209Y1A0523@krmce.ac.in	Hubair
66	209Y1A0522	B. Kashyap Shivvardhan	2 nd year, CSE	209Y1A0522@krmce.ac.in	B. Kashyap
67	209Y1A0538	C. Mahesh	2 nd year, CSE	209Y1A0538@krmce.ac.in	C. Mahesh
68	209Y1A0521	B. Pranay Kumar	2 nd year, CSE	209Y1A0521@krmce.ac.in	B. Pranay
69	209Y1A0524	B. Jaiswanti Kumar	2 nd year, CSE	209Y1A0524@krmce.ac.in	B. Jaiswanti





K.S.R.M. COLLEGE OF ENGINEERING

(UGC-AUTONOMOUS)

Kadapa, Andhra Pradesh, India- 516 003

Approved by AICTE, New Delhi & Affiliated to JNTUA, Ananthapuramu.

An ISO 14001:2004 & 9001: 2015 Certified Institution



Workshop on “How to Prepare to Get Job in Product Based Company?”

22-July-2022

Feedback responses

S.No.	Year & Semester	Branch	Is the course content met your expectation	Is the lecture sequence well planned	The contents of the course is explained with examples	Is the level of course high	Is the course exposed you to the new knowledge and practices	Is the lecturer clear and easy to understand	Rate the value of course in increasing your skills	Any issues
1	B.Tech IV sem	CSE	Yes	Yes	Agree	Agree	Strongly agree	4	5	Good
2	B.Tech IV sem	CSE	Yes	Yes	Agree	Agree	Strongly agree	5	5	Good
3	B.Tech IV sem	CSE	Yes	Yes	Agree	Agree	Strongly agree	4	5	Nothing
4	B.Tech IV sem	CSE	Yes	Yes	Agree	Agree	Strongly agree	5	4	Nothing
5	B.Tech IV sem	CSE	Yes	Yes	Agree	Agree	Strongly agree	5	4	very good
6	B.Tech IV sem	CSE	Yes	Yes	Agree	Agree	Strongly agree	4	4	very good
7	B.Tech IV sem	CSE	Yes	Yes	Strongly agree	Agree	Strongly agree	4	4	Nothing
8	B.Tech IV sem	CSE	Yes	Yes	agree	Agree	Strongly agree	4	5	no
9	B.Tech IV sem	CSE	Yes	Yes	Strongly agree	Agree	Strongly agree	5	4	Nothing
10	B.Tech IV sem	CSE	Yes	Yes	Strongly agree	Agree	Strongly agree	5	5	Good
11	B.Tech IV sem	CSE	Yes	Yes	Agree	Agree	Strongly agree	5	4	Good
12	B.Tech IV sem	CSE	Yes	Yes	agree	Agree	Strongly agree	4	5	Good
13	B.Tech IV sem	CSE	Yes	Yes	agree	Agree	Strongly agree	4	5	Good

46	B.Tech IV sem	CSE	Yes	Yes	Strongly agree	Agree	Strongly agree	2	5	Nothing
47	B.Tech IV sem	CSE	Yes	Yes	agree	Agree	Strongly agree	2	5	very good
48	B.Tech IV sem	CSE	Yes	Yes	agree	Agree	Strongly agree	4	5	very good
49	B.Tech IV sem	CSE	Yes	Yes	Strongly agree	Agree	Strongly agree	5	5	very good
50	B.Tech IV sem	CSE	Yes	Yes	Strongly agree	Agree	Strongly agree	4	5	Nothing
51	B.Tech IV sem	CSE	Yes	Yes	agree	Agree	Strongly agree	4	5	Good
52	B.Tech IV sem	CSE	Yes	Yes	agree	Agree	Strongly agree	4	5	Good
53	B.Tech IV sem	CSE	Yes	Yes	agree	Agree	Strongly agree	4	5	Nothing
54	B.Tech IV sem	CSE	Yes	Yes	agree	Agree	Strongly agree	4	5	Nothing
55	B.Tech IV sem	CSE	Yes	Yes	agree	Agree	Strongly agree	4	5	Nothing
56	B.Tech IV sem	CSE	Yes	Yes	agree	Agree	Strongly agree	4	5	Good
57	B.Tech IV sem	CSE	Yes	Yes	agree	Agree	Strongly agree	5	5	Good
58	B.Tech IV sem	CSE	Yes	Yes	agree	Agree	Strongly agree	5	5	very good
59	B.Tech IV sem	CSE	Yes	Yes	Strongly agree	Agree	Strongly agree	5	5	very good
60	B.Tech IV sem	CSE	Yes	Yes	Strongly agree	Agree	Strongly agree	5	5	Nothing
61	B.Tech IV sem	CSE	Yes	Yes	agree	Agree	Strongly agree	5	5	Good
62	B.Tech IV sem	CSE	Yes	Yes	agree	Agree	Strongly agree	5	5	Good
63	B.Tech IV sem	CSE	Yes	Yes	Strongly agree	Agree	Strongly agree	5	5	Good
64	B.Tech IV sem	CSE	Yes	Yes	Strongly agree	Agree	Strongly agree	2	5	Nothing
65	B.Tech IV sem	CSE	Yes	Yes	agree	Agree	Strongly agree	2	5	very good
66	B.Tech IV sem	CSE	Yes	Yes	agree	Agree	Strongly agree	4	5	very good
67	B.Tech IV sem	CSE	Yes	Yes	Strongly agree	Agree	Strongly agree	5	5	very good
68	B.Tech IV sem	CSE	Yes	Yes	agree	Agree	Strongly agree	5	5	Good
69	B.Tech IV sem	CSE	Yes	Yes	agree	Agree	Strongly agree	5	5	very good
70	B.Tech IV sem	CSE	Yes	Yes	Strongly agree	Agree	Strongly agree	4	4	Nothing
71	B.Tech IV sem	CSE	Yes	Yes	agree	Agree	Strongly agree	4	5	no
72	B.Tech IV sem	CSE	Yes	Yes	Strongly agree	Agree	Strongly agree	5	4	Nothing

1. *Reddy* 2. *Joseph* 3. *Hakim*

Reddy
Dr. V. LOKESWARA REDDY
M.Tech, Ph.D.,
Professor & HOD CSE
K.S.R.M. College of Engineering (Autonomous)
KADAPA - 516 003.

V. S. S. Murthy
V. S. S. MURTHY
PRINCIPAL
K.S.R.M. COLLEGE OF ENGINEERING
KADAPA-516003. (A.P.)



K.S.R.M. COLLEGE OF ENGINEERING

(UGC - Autonomous)

Kadapa, Andhra Pradesh, India- 516 003

Approved by AICTE, New Delhi & Affiliated to JNTUA, Ananthapuramu.



KSNR
1984

How to Preapare to Get Job In Product based company ?



Computer Science & Engineering



22-07-2022



MB 301

Coordinators

Dr V.Lokeswara Reddy.HOD,CSE.

Dr. S.M Farooq,Assoc Prof,CSE.

Sri .B. Mahesh ReddyAsst.Prof,CSE.

Resource person

Dr. G.MURALI,

Assistant Professor

Dept. Of CSE, JNTUACEP.



Instagram: [kasmceofficial](#)



Website: www.kasmce.ac.in

Phone: 8143731980, 8575697569



K.S.R.M. COLLEGE OF ENGINEERING

(UGC-AUTONOMOUS)

Kadapa, Andhra Pradesh, India- 516 005

Approved by AICTE, New Delhi & Affiliated to JNTUA, Ananthapuramu.

An ISO 14001:2004 & 9001: 2015 Certified Institution



Lr./KSRMCE/Department of ME/2021-22/

Date: 13-09-2021

To,
The Principal,
K.S.R.M. College of Engineering,
Kadapa.

98

Respected Sir,

//THROUGH PROPER CHANNEL//

Sub:KSRMCE-Department of ME-Permission and Financial Assistance for AUTO CAD HAKATHON - Requested-Reg.

It is Brought to Your Kind Notice that, Department of Mechanical Engineering of our organization was planning to conduct a Two day HAKATHON ON AUTOCAD for V sem Students of the department. Details of syllabus, students registered and schedule are over leafed for your kind reference. In this Regard we Kindly request you to Provide Permission and Financial Assistance to procure the needs and for smooth completion of the program, for which kind of act we would be grateful to you sir.

Thanking you

Yours Faithfully,

Sri B.SRIHARI

Sri S. Mahaboob Khan

(Course Coordinators Dept of ME)

Forwarded to
Principal Sir
W. J. J. J.

Permitted
V.S.S. Mue/5



K.S.R.M. COLLEGE OF ENGINEERING

(UGC-AUTONOMOUS)

Kadapa, Andhra Pradesh, India- 516 005

Approved by AICTE, New Delhi & Affiliated to JNTUA, Ananthapuramu.

An ISO 14001:2004 & 9001: 2015 Certified Institution



Cr ./KSRMCE/(ME./ACADAMICS)/2021-22/

Date: 14/09/2021

CIRCULAR

It is here by informed to all the 3rd year Mechanical Engineering students that the department is going to organize a Two day AUTOCAD HAKATHON from 17/9/2021 to 18/9/2021. Hence all the interested students are requested to enroll their names with the coordinator Sri S.Mahaboob Khan.

HOD

**Professor & Head
Department of Mechanical Engineering
K.S.R.M. College of Engineering
KADAPA - 516 003.**

CC to :

The HOD, Department of Mechanical, K.S.R.M.C.E

IQAC, K.S.R.M.C.E

3rd Year students

Coordinator



/ksrmce.ac.in

Follow Us:



/ksrmceofficial



K.S.R.M. COLLEGE OF ENGINEERING

(UGC - Autonomous)

Kadapa, Andhra Pradesh, India- 516 003

Approved by AICTE, New Delhi & Affiliated to JNTUA, Ananthapuramu.

Department of Mechanical Engineering



KSNR
lives on..

HACKATHON

Topic: AUTO CAD

Venue:

Engineering Graphics & Design Lab

Coordinators

B.SRIHARI Asst.professor

S.MAHABOOB KHAN Asst.professor



Date&Time

17-09-2021 to 18-9-2021
10:00 A.M to 12:00 Noon
2:00 P.M to 4:00 P.M

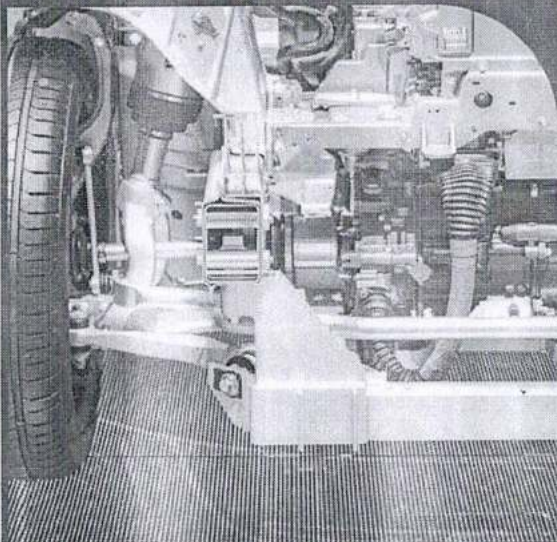

DR.D.RAVIKANTH
HOD

DR. V.S.S. MURTHY
(Principal)

PROF. A. MOHAN
(Director)

SRI K. CHANDRA OBUL REDDY
(Management Member)

SMT. K. RAJESWARI
(Correspondent, Secretary, Treasurer)

SRI K. MADAN MOHAN REDDY
(Vice-chairman)

SRI. K. RAJA MOHAN REDDY
(Chairman)



[ksrmceofficial](https://www.facebook.com/ksrmceofficial)



8143731980, 8575697569



K.S.R.M. COLLEGE OF ENGINEERING

(UGC-AUTONOMOUS)

Kadapa, Andhra Pradesh, India- 516 005

Approved by AICTE, New Delhi & Affiliated to JNTUA, Ananthapuramu.

An ISO 14001:2004 & 9001: 2015 Certified Institution



ACTIVITY REPORT

AUTO CAD HACKATHAN

17 & 18TH SEP 2021

- Target Group** : V sem Mechanical students
Details of Participants : 41
- Coordinator(s)** : Sri. B. SriHari
Sri . S.Mahaboob Khan
- Organizing Department** : Mechanical Engineering
Plat Form : Off line
Venue : Engineering Graphics and Design Lab
- Description** :

Learning to use a CAD system is similar to learning a new language. It is necessary to begin with the basic alphabet and learn how to use it correctly and effectively through practice. This will require learning some new concepts and skills as well as learning a different vocabulary. Today, the majority of the Mechanical CAD systems are capable of creating three-dimensional solid models. Nonetheless, all CAD systems create designs using basic geometric entities and many of the constructions used in technical designs are based upon two-dimensional planar geometry. The method and number of operations that are required to accomplish the basic planar constructions are different from one system to another. AutoCAD provides many different ways to accomplish the same task. For example, to activate a command, you can select it from a menu or a toolbar, or type the command name at AutoCAD's command prompt. There is no right or wrong way to do something in AutoCAD. You will develop techniques that you find most comfortable for the way you work and the types of drawings you create.

You may want to customize AutoCAD for your particular needs. There are also many common drafting tasks that can be automated by using scripts and macros, or by writing or purchasing add-on applications that run inside AutoCAD, tailoring the program for specific drafting and design disciplines. In this we illustrate AutoCAD objects line, circle, rectangle, arc, ellipse, and polygon, by drawing different shapes and apply the three methods of coordinate system and compare between them: Absolute Coordinate System, Relative Coordinate System and Polar Coordinate System.



K.S.R.M. COLLEGE OF ENGINEERING

(UGC-AUTONOMOUS)

Kadapa, Andhra Pradesh, India- 516 005

Approved by AICTE, New Delhi & Affiliated to JNTUA, Ananthapuramu.

An ISO 14001:2004 & 9001: 2015 Certified Institution

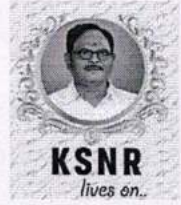

List of Contents

Chapter 1: AutoCAD Interface

Chapter 2: Basic Objects in AutoCAD

Chapter 3: Modify Commands in AutoCAD

Chapter 4: Layers-

Chapter 5: Animation in AUTOCAD

Chapter 6: Solved Examples

Conclusions

References

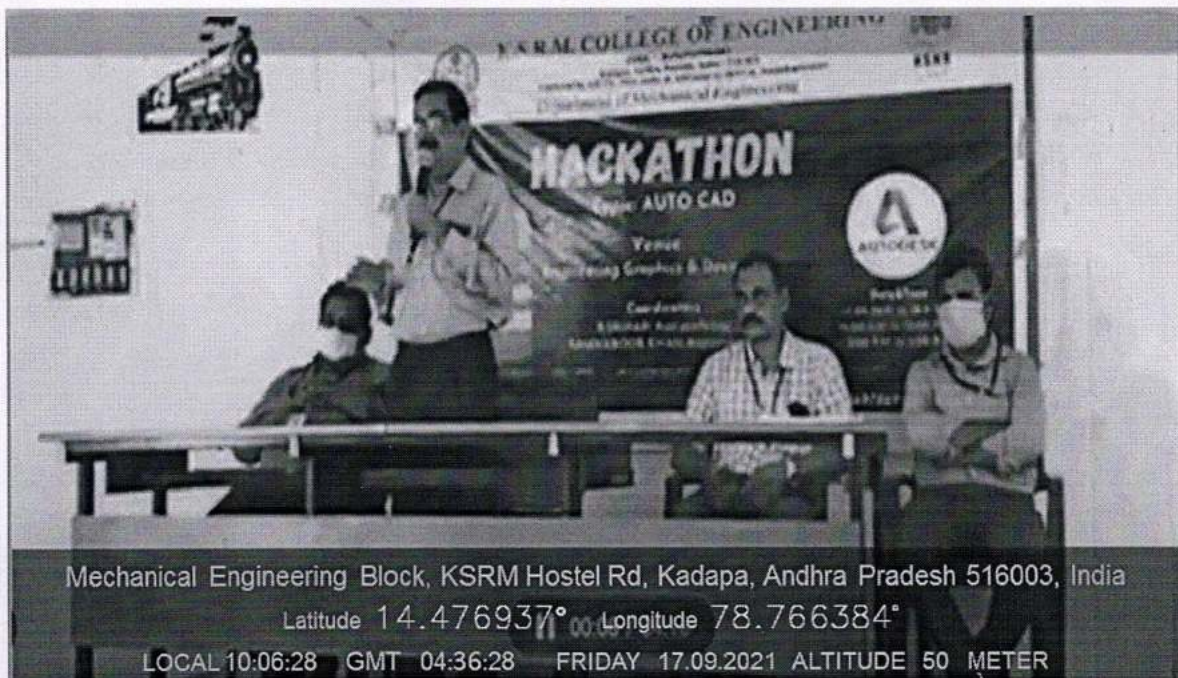

Dr.V. S. Srinivasa Murthy ,Principal explaining the importance of AUTO CAD to the students

 /ksrmce.ac.in

Follow Us:



/ksrmceofficial



K.S.R.M. COLLEGE OF ENGINEERING

(UGC-AUTONOMOUS)

Kadapa, Andhra Pradesh, India- 516 005

Approved by AICTE, New Delhi & Affiliated to JNTUA, Ananthapuramu.

An ISO 14001:2004 & 9001: 2015 Certified Institution

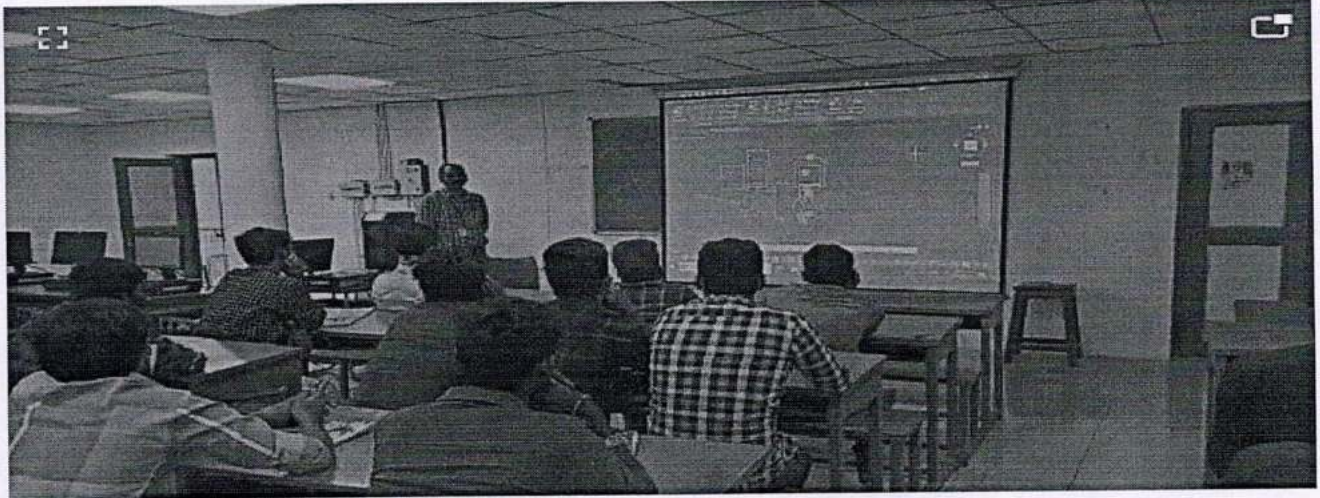

V Sem Mechanical students attending the AUTO CAD program

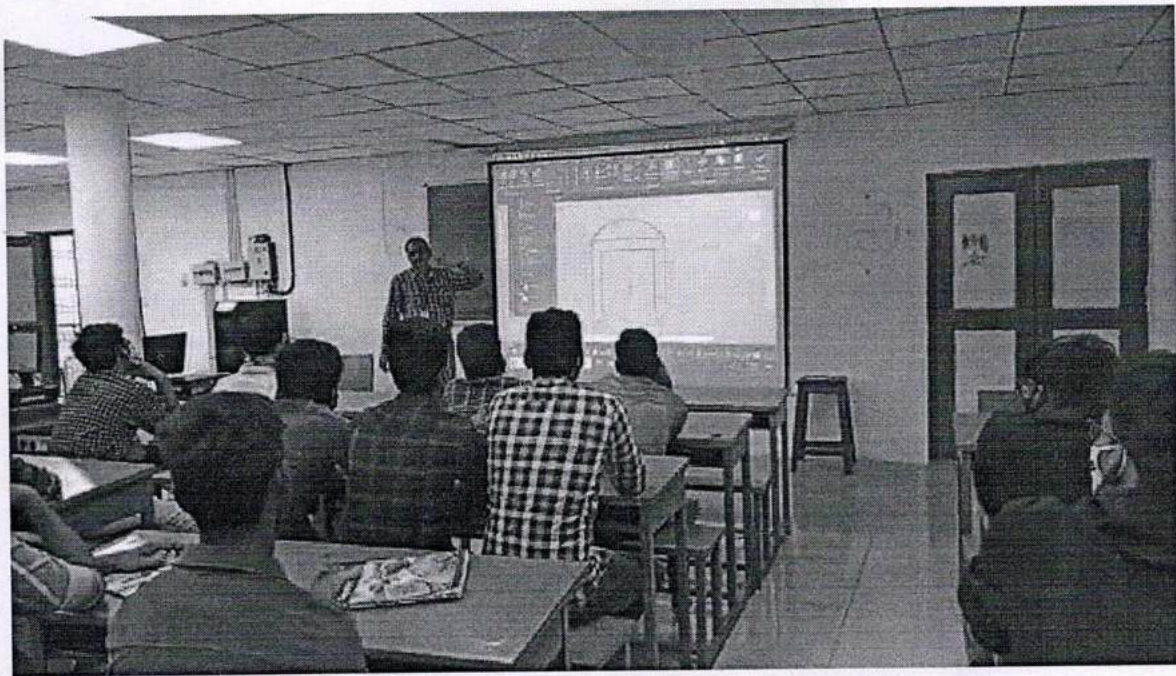

V Sem Mechanical students attending the Animation basics in AUTO CAD program

Coordinator

HOD

Professor & head

Department of Mechanical Engineering

K.S.R.M. College of Engineering

KADAPA - 516 005.

/ksrmce.ac.in

Follow Us:



/ksrmceofficial



K.S.R.M. COLLEGE OF ENGINEERING

(UGC - Autonomous)

Kadapa, Andhra Pradesh, India- 516 003

Approved by AICTE, New Delhi & Affiliated to JNTUA, Ananthapuramu.

DEPARTMENT OF MECHANICAL ENGINEERING



Student Registration form

AUTO CAD HAKATHON ON 17th SEP. & 18th SEP 2021

S.NO	REG. .NO.	NAME	STUDENTS SIGNATURE
1.	199Y5A0303	A.rahesh babu	Arahesh babu
2.	189Y1A0366	S. Lingamaiah	S. Lingamaiah
3.	199Y5A0307	C. Sreerivasulu	C. Sreerivasulu
4.	199Y5A0309	G. VEERA PRASAD	G. Veera Prasad
5.	199Y5A0341	V. Sreekanth Reddy	V.S. Reddy
6.	199Y5A0321	M. Sai Teja	M. Sai Teja
7.	199Y5A0315	K. Sivadham Naidu	K. Sivadham Naidu
8.	199Y5A0340	V.M.D. Pramod Raja	V.M.D. Pramod Raja
9.	199Y5A0308	CH. Amarendra Kumar	CH. Amarendra Kumar
10.	199Y5A0337	S. Mahabomb Gowda	S. Mahabomb Gowda
11.	199Y5A0316	K. Venkatesh	K. Venkatesh
12.	199Y5A0338	S. Shekshavali	S. Shekshavali
13.	199Y5A0332	P. Sasi Kant Reddy.	P. Sasi Kant Reddy.
14.	199Y5A0333	R. Anand Reddy	R. Anand Reddy
15.	199Y5A0312	J. Subhan	J. Subhan
16.	209Y5A0325	M. Chennakesava Reddy	M. Chennakesava Reddy
17.	209Y5A0308	D. Srinivasulu	D. Srinivasulu
18.	209Y5A0321	L. Bhuvan	L. Bhuvan
19.	209Y5A0344	Y. Ashok	Y. Ashok
20.	209Y5A0323	M. Bharath Reddy	M. Bharath Reddy
21.	209Y5A0311	G. Dilip Kumar	G. Dilip Kumar
22.	209Y5A0346	Y. Veenu	Y. Veenu
23.	209Y5A0329	F. Adli narayana	F. Adli narayana
24.	209Y5A0340	T. Lakshmanan	T. Lakshmanan
25.	209Y5A0316	K. Upendra Reddy	K. U. Reddy
26.	209Y5A0319	L. Sudhakar	L. Sudhakar
27.	209Y5A0342	V. Sravan Kumar	V. Sravan Kumar
28.	209Y5A0330	P. Madhu Sudhan	P. Madhu Sudhan
29.	209Y5A0345	Y. Shashi Kiran Reddy	Y. Shashi Kiran Reddy
30.	209Y5A0326	N. Pavan Kumar	N. Pavan Kumar
31.	209Y5A0331	P. Hari Vardhan Reddy	P. Hari Vardhan Reddy
32.	209Y5A0306	C. Subbarayudu	C. Subbarayudu



K.S.R.M. COLLEGE OF ENGINEERING

(UGC - Autonomous)

Kadapa, Andhra Pradesh, India- 516 003

Approved by AICTE, New Delhi & Affiliated to JNTUA, Ananthapuramu.

DEPARTMENT OF MECHANICAL ENGINEERING



KSNR
lives on.

S.NO	REG. .NO.	NAME	STUDENTS SIGNATURE
33.	209Y5A0338	S. Yed - Farooq	S. Farooq
34.	209Y5A0339	S. Samiuddin	S. Prof
35.	209Y5A0302	B. Nagabhiva	B. Nay
36.	209Y5A0334	S. Mahammad Ali	S. S. Prof
37.	209Y5A0336	S. Maj Ahmed	A. Prof
38.	209Y5A0343	Y. Hemanth Kumar	Y. Hemanth Kumar
39.	209Y5A0311	G. Charan Kumar Reddy.	G. Charan Kumar Reddy.
40.	209Y5A0332	P. Nazeer Basha	P. Nazeer Basha
41.	209Y5A0314	J. Abulhasan.	J. Abulhasan
42.			
43.			
44.			
45.			
46.			
47.			
48.			
49.			
50.			
51.			
52.			
53.			
54.			
55.			
56.			
57.			
58.			
59.			
60.			
61.			
62.			
63.			
64.			

Professor & head
Department of Mechanical Engineering
K.S.R.M. College of Engineering
KADAPA - 516 003.



K.S.R.M. COLLEGE OF ENGINEERING

(UGC-AUTONOMOUS)

Kadapa, Andhra Pradesh, India- 516 005

Approved by AICTE, New Delhi & Affiliated to JNTUA, Ananthapuramu.

An ISO 14001:2004 & 9001: 2015 Certified Institution



List of participants

S.NO	REG.NO	NAME	FN	AN
1	1994SA228	A. Mahesh babu	✓	✓
2	18941A0366	S. Lingamach	✓	✓
3	1994SA0307	C. Sreenivasulu	✓	✓
4	1994SA0309	G. Veera Prasad	✓	✓
5	1994SA0341	V. Sreelaksh Reddy	✓	✓
6	1994SA0321	M. Sai Teja	✓	✓
7	1994SA0315	V.M.D. Pramod Raju	✓	✓
8	1994SA0308	C.H. Amarendra	✓	✓
9	1994SA0387	S. Mahesh Babu	✓	✓
10	1994SA0316	K. Venkatesh	✓	✓
11	1994SA0340	K. Sriyam Nail	✓	✓
12	1994SA0338	S. Shekharvelli	✓	✓
13	1994SA0332	P. Sasi Kanth Reddy	✓	✓
14	1994SA0333	R. Anand Reddy	✓	✓
15	1994SA0312	J. Subhan	✓	✓
16	2094SA0325	M. Chennakesava Reddy	✓	✓
17	2094SA0308	D. Srinivasulu	✓	✓
18	2094SA0311	C. Bhushan	✓	✓
19	2094SA0344	Y. Ashok	✓	✓



K.S.R.M. COLLEGE OF ENGINEERING (UGC-AUTONOMOUS)

Kadapa, Andhra Pradesh, India- 516 005

Approved by AICTE, New Delhi & Affiliated to JNTUA, Ananthapuramu.

An ISO 14001:2004 & 9001: 2015 Certified Institution



List of participants

S.NO	REG.NO	NAME	FN	AN
20	20945A0323	M. Bharath Reddy	✓	✓
21	20945A0312	G. Dilip Kumar	✓	✓
22	20945A0346	Y. Venu	✓	✓
23	20945A0339	P. Ali Narayana	✓	✓
24	20945A0340	T. Lalshimanna	✓	✓
25	20945A0316	K. Upendra Reddy	✓	✓
26	20945A0319	L. Sudhanshu	✓	✓
27	20945A0342	V. Sravan Kumar	✓	✓
28	20945A0330	P. Madhu Sudhan	✓	✓
29	20945A0345	Y. Shashikiran Reddy	✓	✓
30	20945A0326	P. Pavan Kumar	✓	✓
31	20945A0331	P. Harivardhan Reddy	✓	✓
32	20945A0306	C. Subbarayudu.	✓	✓
33	20945A0338	S. Yed. Farooq	✓	✓
34	20945A0339	S. Samiuddin	✓	✓
35	20945A0302	B. Nagasiva	✓	✓
36	20945A0334	S. Mahammad Ali	✓	✓
37	20945A0336	S. Maq Ahmed	✓	✓
38	20945A0343	Y. Hemant Kumar	✓	✓



/ksrmce.ac.in

Follow Us:



/ksrmceofficial

K.S.R.M. COLLEGE OF ENGINEERING
(UGC-AUTONOMOUS)
DEPARTMENT OF ,MECHANICAL ENGINEERING

AUTOCAD HAKATHON

Detailed Schedule for a Total 10 Hrs Course

S.No	Date	Topic	No of Hours
Module-1			
1	17-9-2021 F.N	Outline of course. Overview of the AUTOCAD User Interface and suggested settings. Drawing Templates and Sheet Formats : Default Drawing Templates, Sheet Format and Sheet Size, Sketch Entities – Inference line, Centerline line, Line, Circle, Arc, Ellipse, Rectangle, Slots, Polygon, Parabola, Ellipse, Partial Ellipse, Spline, Spline tools, Spline on surface, Equation driven curve, Points, Text, Construction geometry, Snap, grid, Exercises	2 Hrs
2	17-9-2021 A.N	Sketch Tools - Fillet, Chamfer, Offset, Convert entities. Intersection curve, Face curve, Trim, Extend, Split, Jog Line, Construction Geometry, Mirror, Dynamic Mirror, Move, Copy, Rotate, Scale, Stretch, Sketch pattern , Polygon, Make path, Close Sketch To Model, Sketch picture, Check Sketch for Feature, Area hatch/Fill Dimensioning - Smart, Horizontal, Vertical, Ordinate, Horizontal ordinate, Vertical ordinate, Align ordinate, Fully define sketch. Sketch Diagnosis, Sketch Xpert, 3D Sketching, Rapid Sketch Exercises	2Hrs
3	17-9-2021 A.N	Exercises on 2D Sketches	2Hrs

Module-2			
4	18-9-2021 F.N	3D Modeling Tools Creating reference planes Creating Extrude features – Direction1, Direction2, From option, Thin feature, Applying draft, Selecting contours Creating Revolve features – Selecting Axis, Thin features, Selecting contours Creating Swept features- Selecting, Profile and Path, Orientation/twist type, Path Alignment, Guide Curves, Start/End tangency, Thin feature Exercises	3Hrs
5	18-9-2021 A.N	Exercises on 3D modelling	3 Hrs
Total Hours			12 Hrs

Course Coordinators and Resource Persons

Sri B.SRIHARI

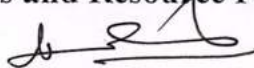

Sri S.MAHABOOB KHAN



HOD

**Professor & head
Department of Mechanical Engineering
K.S.R.M. College of Engineering
KADAPA - 516 003.**

K.S.R.M. COLLEGE OF ENGINEERING
(UGC-AUTONOMOUS)
DEPARTMENT OF ,MECHANICAL ENGINEERING

AUTO CAD HAKATHON

Course objective: To Acquire Basic Knowledge in AUTO CAD works to Model any Design

Module-1

5 Hrs

Sketching: Outline of course, Overview of the Auto CAD,Works User Interface and suggested settings. Drawing Templates and Sheet Formats : Default Drawing Templates, Sheet Format and Sheet Size, New SolidWorks Document, Sheet Format/Size .Drawing Sheet Size and Format. Draw tools, Editing Tool

Sketch Entities – Inference line, Centerline line, Line, Circle, Arc, Ellipse, Rectangle, Slots, Polygon, Parabola, Ellipse, Partial Ellipse, Spline, Spline tools, Spline on surface, Equation driven curve, Points, Text, Construction geometry, Snap, grid,

Sketch Tools - Fillet, Chamfer, Offset, Convert entities, Intersection curve, Face curve, Trim, Extend, Split, Jog Line, Construction Geometry, Mirror, Dynamic Mirror, Move, Copy, Rotate, Scale, Stretch, Sketch pattern , Polygon, Make path, Close Sketch To Model, Sketch picture, Check Sketch for Feature, Area hatch/Fill

Dimensioning - Smart, Horizontal, Vertical, Ordinate, Horizontal ordinate, Vertical ordinate, Align ordinate, Fully define sketch. Sketch Diagnosis, Sketch Xpert, 3D Sketching, Rapid Sketch

Exercises

Module-2

5Hrs

Part Modelling

Part Modeling Tools Creating reference planes Creating Extrude features – Direction1, Direction2, From option, Thin feature, Applying draft, Selecting contours Creating Revolve features – Selecting Axis, Thin features, Selecting contours Creating Swept features-Selecting, Profile and Path, Orientation/twist type, Path Alignment, Guide Curves, Start/End tangency, Thin feature

Creating Loft features – Selecting Profiles, Guide curves, Start/End Constraints, Centerline parameters, Sketch tools, Close loft. Selecting geometries – Selection Manager, Multiple Body concepts Creating Reference - points, axis, coordinates

Creating Chamfer Creating Shell Creating Rib Creating Pattern - Linear pattern, Circular pattern, Sketch driven pattern, Curve driven pattern, Table driven pattern, Fill pattern, mirror

Exercises

Exercises

2Hrs

Course Outcomes:

After Successful completion of the course the students will be able to
CO1. Demonstrate competency with multiple drawing and modification commands in auto cad.

CO2. Create three-dimensional solid models.

CO3. Create three-dimensional assemblies incorporating multiple solid models.

CO4. Apply industry standards in the preparation of technical mechanical drawings.

Course Coordinators and Resource Persons

Sri B.SRIHARI

Sri S.MAHABOOB KHAN



HOD

Professor & head
Department of Mechanical Engineering
K.S.R.M. College of Engineering
NADAPA - 516 003.

AUTOCAD 2D EXAMPLES

1. Draw following figures using line commands.

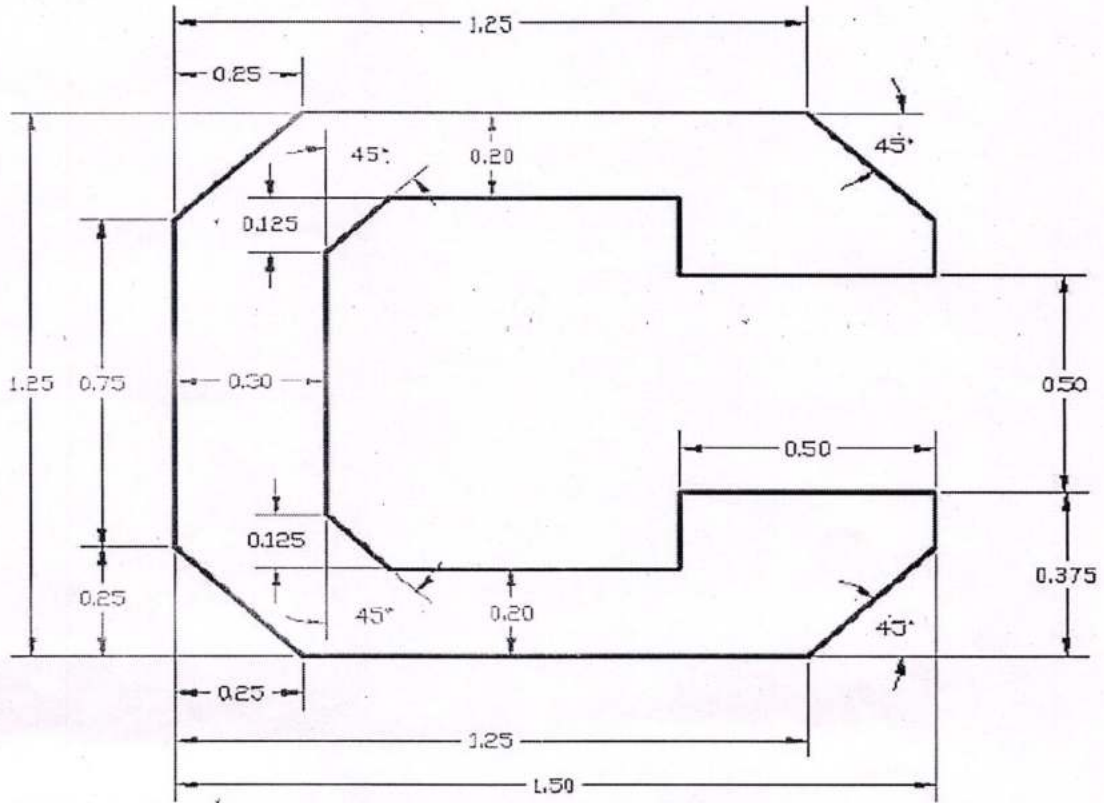

2.

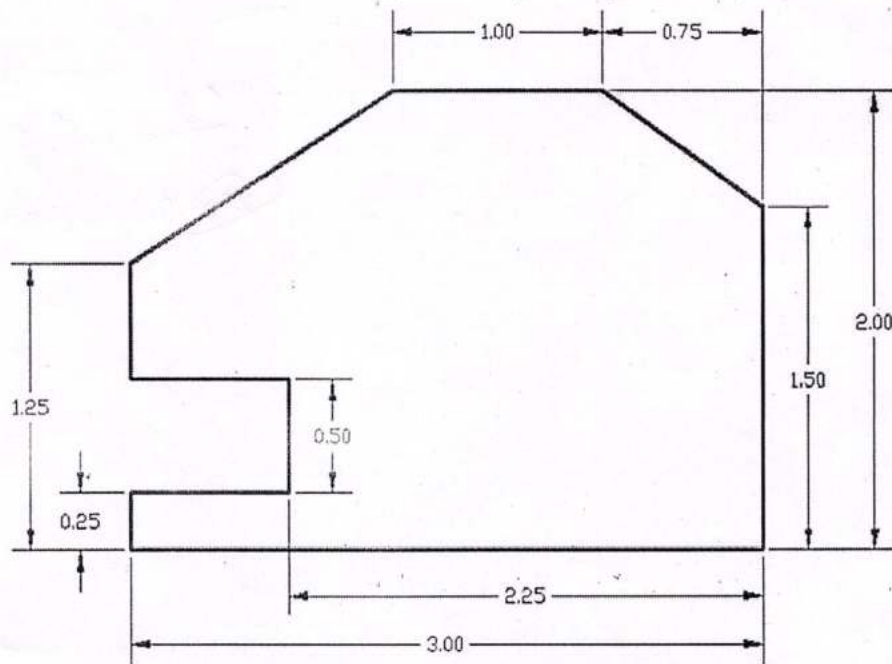

Example 1. Add hatch to the following figures:

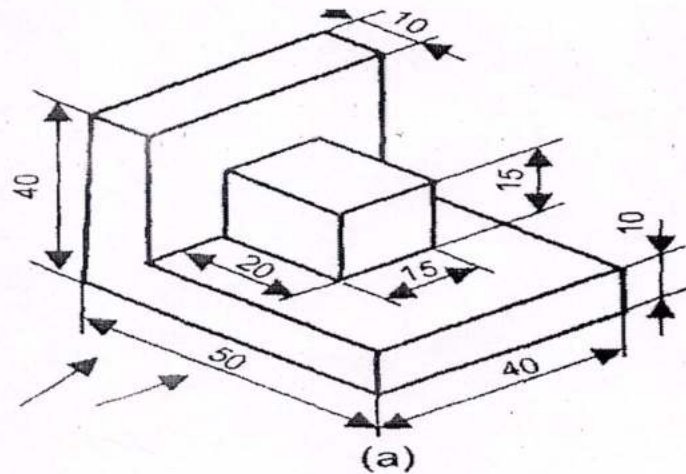
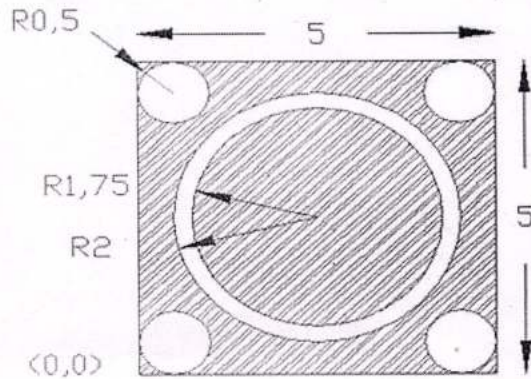
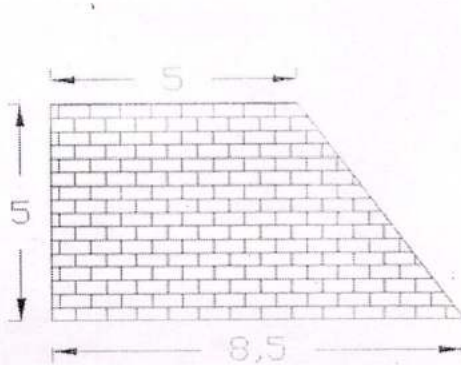
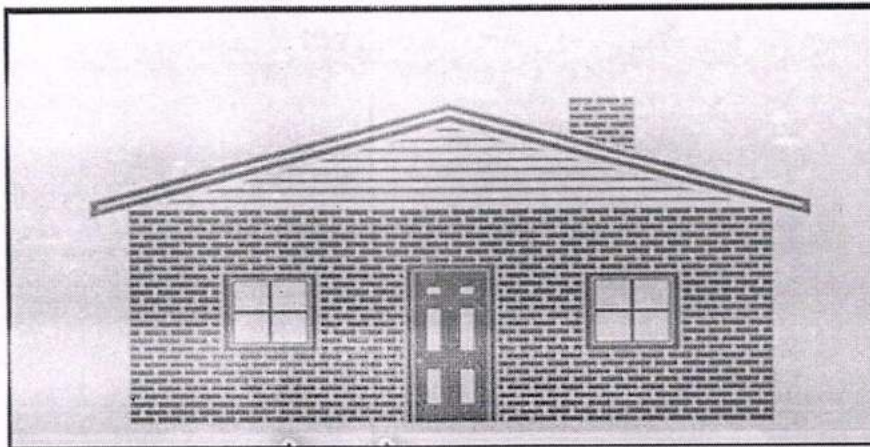

3D EXAMPLES

(a)

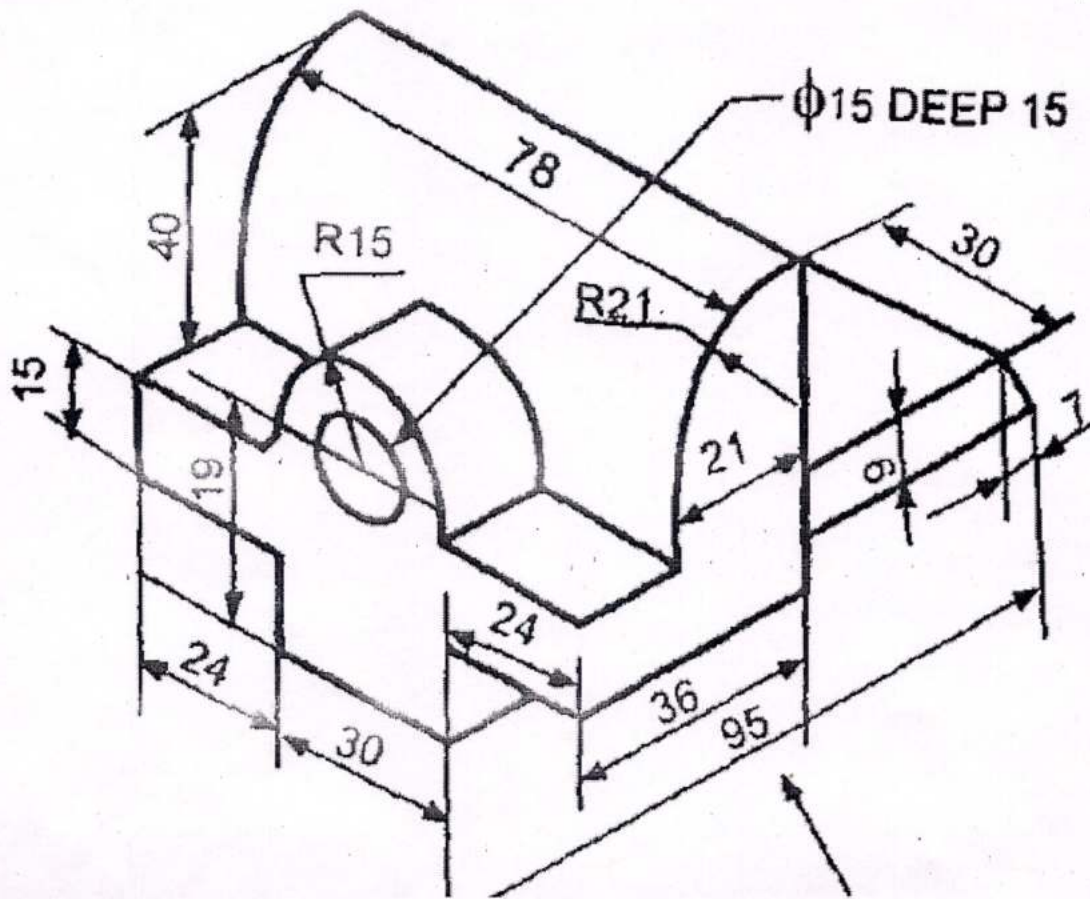

Course Coordinators

Sri B.SRIHARI

Sri S.MAHABOOB KHAN

W. Subbar

HOD

Professor & head
 Department of Mechanical Engineering
 K.S.R.M. College of Engineering
 NADAPPA - 518 003.



**K.S.R.M COLLEGE OF ENGINEERING
(AUTONOMOUS)
KADAPA-516003, A.P, INDIA**



Certificate of Participation



KSNR
lives on..

THIS IS TO CERTIFY THAT P.ADINARAYANA (209Y5A0329) HAS PARTICIPATED IN TWO DAYS OFFLINE WORKSHOP ON 'HACKATHON ON AUTOCAD', ORGANIZED BY DEPARTMENT OF MECHANICAL ENGINEERING, K.S.R.M COLLEGE OF ENGINEERING, KADAPA FROM 17-09-2021 TO 19-09-2021

CERTIFICATE ID:MEHAC.17/18/2021-01

Sri.B.Srihari, S.Mahaboob khan
Coordinators

Dr.D.Ravikanth
Prof&HOD

Dr.V.S.S Murthy
Principal



K.S.R.M. COLLEGE OF ENGINEERING

(UGC-AUTONOMOUS)

Kadapa, Andhra Pradesh, India- 516 003

Approved by AICTE, New Delhi & Affiliated to JNTUA, Ananthapuramu.

An ISO 14001:2004 & 9001: 2015 Certified Institution



FEED BACK FORM FOR AUTOCAD HACKTHON

Name of the student, Roll no: S. Maj Ahamed, 20948A0336

Year of the Study & Student Mail ID: III year / ahamed.shaik maj@gmail.com.

Name of the college: K.S.R.M. collage of Engineering.

Name of the district: Kadapa.

Name of the state: Andhra Pradesh

How would you rate the session { 1 }

1. Excellent 2. verygood 3. good 4. Fair

Quality and content of the talk of the speaker { 1 }

1. Excellent 2. verygood 3. good 4. Fair

Have you reached expectations { 1 }

1. Yes 2. No

Suggestions if any Nothing

Name of the coordinators

S. Maj Ahamed
SIG OF THE PARICIPANT

B. Srihari ASST. PROF

S. Mahaboob khan ASST. PROF

K.S.R.M. COLLEGE OF ENGINEERING, KADAPA

(An Autonomous Institution)

(Approved by AICTE, Accredited by NAAC, Affiliated To JNTUA, Ananthapuram)

(An ISO 9001:2015 Certified Institution)





KSNR
lives on..

CERTIFICATE OF PARTICIPATION

This is to certify that his/her..... S.M.D. MANSOOR.....

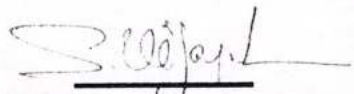
of..... B Tech Mechanical Engineering Department has participated in A National Level Students Technical Symposium on **CAME-2K22 (COMPUTER APPLICATIONS IN MECHANICAL ENGINEERING)** held on 15-Feb-2022 Organised by Mechanical Engineering Department, KSRMCE KADAPA.

Co-Ordinator
ME-Department

Co-Ordinator
ME-Department

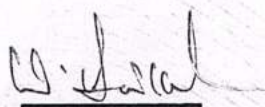
HOD
ME-Department

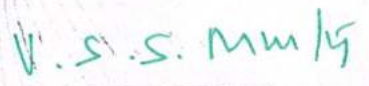
Principal
KSRMCE



K.S.R.M. COLLEGE OF ENGINEERING

(UGC-AUTONOMOUS)

Kadapa, Andhra Pradesh, India- 516 003

Approved by AICTE, New Delhi & Affiliated to JNTUA, Ananthapuramu.

An ISO 14001:2004 & 9001: 2015 Certified Institution



Lr./KSRMCE/Dept. of ECE/2021-22/

Date: 09.10.2021

To

The Principal,
K.S.R.M.College of Engineering
Kadapa.

Respected Sir,

//THROUGH PROPER CHANNEL//

Sub: KSRMCE - Dept. of ECE - **Subject** - Requisition to Organize a Two Day Workshop On "**Ethical Hacking**" - For Students on October 22nd and 23rd, 2021- Reg.

It is being brought to your kind notice that, the Department of ECE is planning to organize a Two Day Workshop On "Ethical Hacking" - For Students on October 23rd and 24th, 2021 for a target group of II, III and IV B.Tech. students. In this regard I kindly request you to permit us to utilize DSP LAB in S.J. Block for organizing this workshop, for which kind of act I would be grateful to you sir.

Thanking you

Yours Faithfully

Md Mahaboob Pasha,
Assistant Professor, ECE
Coordinator

Cc:

To The Director for Information

To All Deans / HoD's

Permitted
V. S. S. M. M. 15
09/10/2021



K.S.R.M. COLLEGE OF ENGINEERING (UGC-AUTONOMOUS)

Kadapa, Andhra Pradesh, India- 516 003

Approved by AICTE, New Delhi & Affiliated to JNTUA, Ananthapuramu.

An ISO 14001:2004 & 9001: 2015 Certified Institution



Cr./KSRMCE/ (Department of E.C.E)/2021-22/

Date: 20-10-2021

Circular

It is hereby informed that A Two Day Workshop On "**ETHICAL HACKING**" is going to be organized by the department of E.C.E on 22nd and 23rd October, 2021 in DSP Lab – SJ BLOCK.

In this connection, all the B. Tech ECE students and faculty are hereby directed to attend without fail.

HEAD OF THE DEPARTMENT

Cc to:

IQAC

KSRMCE



K.S.R.M. COLLEGE OF ENGINEERING

(AUTONOMOUS)

Kadapa, Andhra Pradesh, India- 516 003

Approved by AICTE, New Delhi & Affiliated to JNTUA, Ananthapuramu.

An ISO 14001:2004 & 9001: 2015 Certified Institution



ACTIVITY REPORT

A Two Day Workshop

On

"ETHICAL HACKING"

22nd and 23rd October, 2021

Target Group	:	Students
Details of Participants	:	34
Co-coordinator(s)	:	Md. Mahaboob Pasha
Organizing Department	:	Electronics and Communication Engineering
Venue	:	DSP Lab – SJ BLOCK

Description: Department of ECE, K.S.R.M College Of Engineering has conducted a 2 day Hands on workshop on "Ethical Hacking" on 22nd and 23rd October, 2021 in association with the company "Algorithm Edu-Space". The resource person for the workshop was Mr. Dawood Ansar, Certified Ethical Hacker (CEH), recognized by EC Council. It was a complete hands on experience for the students where they tested many live websites for hacking and also learned how to hack into systems. The resource person was very knowledgeable, learned and joyful while teaching. Students were very happy to see themselves able to hack into systems and websites. The workshop gave insights on career path in the domain of Pen - testing and Cyber Security. Students were issued with a certificate of participation at the end of the workshop. The workshop was an overall success.



[/karmce.ac.in](http://karmce.ac.in)

Follow Us:



[/karmceofficial](https://www.facebook.com/karmceofficial)

K.S.R.M. COLLEGE OF ENGINEERING
(UGC - Autonomous)
Kadapa, Andhra Pradesh, India- 516 003
Approved by AICTE, New Delhi & Affiliated to JNTUA, Ananthapuramu.

DEPARTMENT OF ELECTRONICS AND COMMUNICATION ENGINEERING

TWO DAY WORKSHOP ON
"ETHICAL HACKING"
In Association with Algorithm Edu-Space

Faculty Coordinator:
Sri. Md. Mahaboob Pasha,
M.Tech

Date of Event:
22 nd to 23 rd October, 2021

Resource Person:
Sri. Dawood Ansar

Student Coordinators
1) Adwaith 2) Kshitij

Venue: KSRM College of Engineering, ECE Dept, kadapa

[Ksrmceofficial](#) www.ksrmce.ac.in 8143731980, 8575697569

Figure 1: Workshop Banner

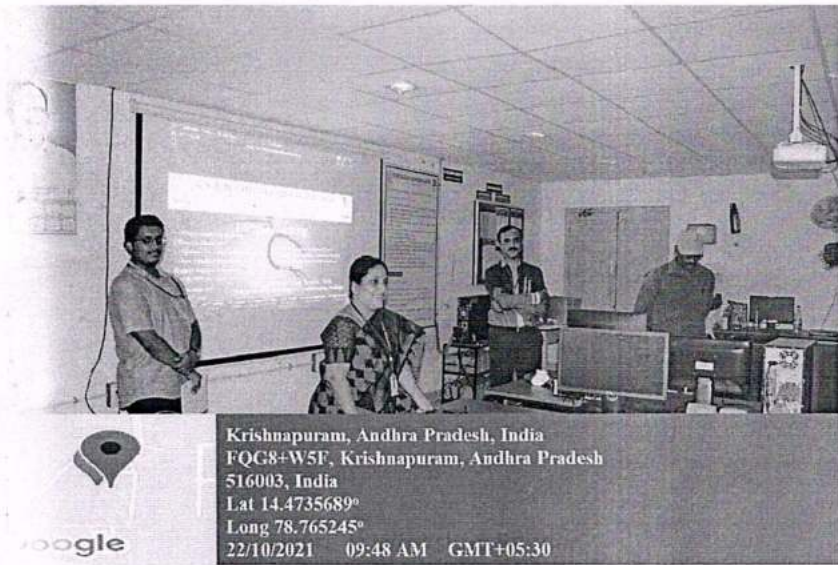

Figure 2: Dr. G. Hemalatha, HOD, addressing the participants in the Inauguration session

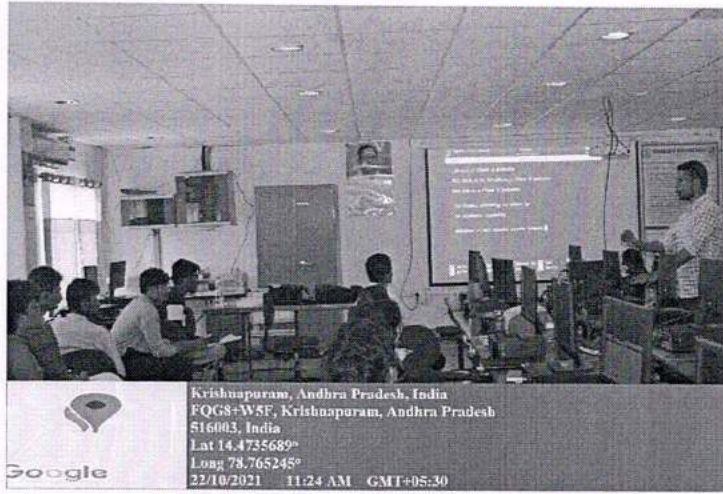

Figure 3: Resource Person Sri Dawood Ansar explaining the concepts



Figure 4: Participants of the workshop

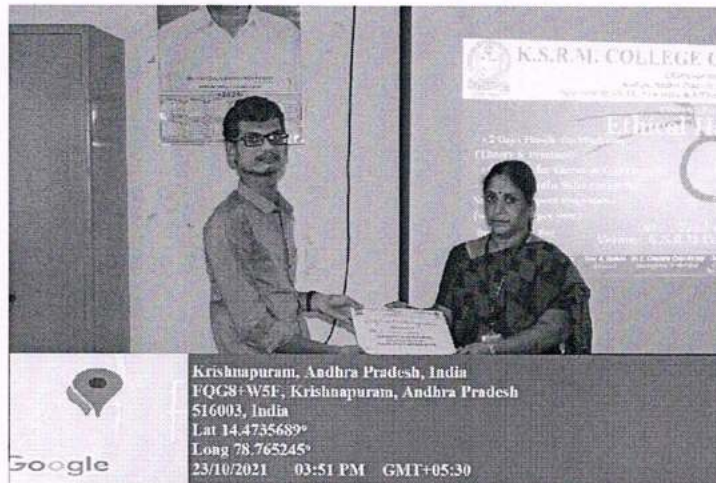

Figure 5: Certificates Distribution to participants

[Handwritten Signature]
Co-ordinator

[Handwritten Signature]
HOD



K.S.R.M. COLLEGE OF ENGINEERING

(AUTONOMOUS)

Kadapa, Andhra Pradesh, India- 516 003

Approved by AICTE, New Delhi & Affiliated to JNTUA, Ananthapuramu.

An ISO 14001:2004 & 9001: 2015 Certified Institution



Department of ECE

Two - Day Workshop on "Ethical Hacking", 22nd and 23rd October, 2021

REGISTRATION FORM

Sl. No.	Name of the Student	College Name and Place	Contact No.	Email ID	Signature
1	k. vamsivaradhan Reddy	S. V. Degree College (Balaji Nagar)	9381791962	k.vamsivaradhanreddy123@gmail.com	k. Jaysi
2	k. Sivamani	S.V. College of Engineering	6303609307	ksivamani1523@gmail.com	K Sivamani
3	S. Pavan Kumar	SIV degree college	9676828687	S.Pavan Somapavan kumar 143@gmail.com	S.Pavan
4	M. Hemanth kumar Reddy	S.V. Degree college	9063805371	mallireddy hemanth07@gmail.com	M. Hemanth k. Reddy
5	B. Mani Kiran Reddy	Kanchi university	9010521498	Manikiranreddy2001@gmail.com	Mani Kiran Reddy
6	N. Yaswanth Reddy	S.V. Engineering College	8555938252	Yaswanthreddy8776@gmail.com	N. Yaswanth
7	A. Jayabharan Reddy	S.V. Degree college	6300805336	jayabharanreddy98@gmail.com	A. Jayabharan Reddy
8	B. Avanthika	S.V. College of Engineering	6303498508	jyothivanthika47@gmail.com	B. Avanthika
9	k. susmitha	S.V. college of engineering	9398860823	kunjeti.susmitha@gmail.com	k. susmitha



/ksrmce.ac.in

Follow Us:



/ksrmceofficial

Sl. No	Name of the Student	College Name and Place	Contact No.	Mail ID	Signature
10	YADATI VISHNU TEJA	Sri Venkateswara College of Engineering	9381820134	thisisvishnutreja@hotmail.com	Y. Vishnu Teja
11	Y. Mallikharjun Reddy	S.V. Degree college	7337307332	mallym1435@gmail.com	Y. Mallikharjun Reddy
12	G. Maneesh Kumar Reddy	S.V Degree college	9398464300	manimaneesh33@gmail.com	G. Maneesh
13	K. Mallikarjuna	SV Degree college	9182001296	malikarjunaK2203@gmail.com	K. Mallikarjuna
14	K. Sunay Kumar	SV Eng college	910748882	kunjaisunay@gmail.com	K. Sunay Kumar
15	S. Munazzah Fatima	KSRMCE Kadapa	7981645819	munazzah.711f@gmail.com	S. Fatima
16	S. Meha Taj	KSRMCE Kadapa	6302673357	mehatajshaik16@gmail.com	S. Meha Taj
17	Y. Sowmyalatha	KSRMCE Kadapa	7281938160	yagala.sowmyalatha2002@gmail.com	Y. Sowmyalatha
18	S. Sivakumari	KSRMCE Kadapa	9346304278	18941A04E4@kasmce.ac.in	S. Sivakumari
19	T. Bhavani	KSRMCE kadapa	6309374377	18941A04E4@kasmce-ac.in	T. Bhavani
20	T. Guru Chandana	KSRMCE kadapa	9652424602	18941A04E3@kasmceac.in	T. Chandana

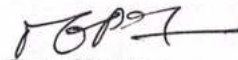



Coordinator

Resource Person

HOD

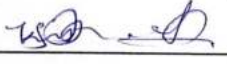
Principal

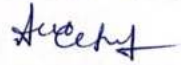
PRINCIPAL
K.S.R.M. COLLEGE OF ENGINEERING
KADAPA - 516 003. (A.P.)

Sl. No	Name of the Student	College Name and Place	Contact No.	Mail ID	Signature
21	Yellala. Palguna Reddy.	KSRMCE, Kadapa	7661997632	18941A04B1@ksrmce.ac.in	Y. Palguna Reddy.
22	Sheela Krishna Teja	KSRMCE, Kadapa	6303404694	shilekris177@gmail.com	
23	Y. Otsul Reddy	KSRMCE Kadapa	8247257076	otsulreddy8247@gmail.com	Y. Otsul Reddy
24	T. Narahan Deep Gupta	K.SRMCE - KADAPA	9515703357	tatomsettydeepu@gmail.com	T. Narahan Deep
25	S. Pavan Sai	KSRMCE - Kadapa	9440089912	18941A04D8@ksrmce.ac.in	S. Pavan Sai
26	V. Vishnu Vardhan	KSRMCE - Kadapa	6303316442	18941A04F4@ksrmce.ac.in	
27	Y. Sai Krishna Reddy	KSRMCE - Kadapa	9398065913	Sai Sai Sai Sai 82929@gmail.com	Y. Sai Krishna Reddy
28	V. Harshith Reddy	KSRMCE - Kadapa	9346467396	18941A04E8@ksrmce.ac.in	V. Harshith Reddy
29	V. Annamaya	KSRMCE - Kadapa	6303214412	18941A04E9@ksrmce.ac.in	V. Annamaya
30	U. Sree Harsha	KSRMCE - Kadapa	6281502001	18941A04E7@ksrmce.ac.in	U. Sree Harsha
31	S. Athar	KSRMCE - Kadapa	6306393608	18941A04D7@ksrmce.ac.in	



Sl. No	Name of the Student	College Name and Place	Contact No.	Mail ID	Signature
32	Syed. Mohammed Tahis	KSRMCE - Kadapa	7702934139	189Y1A04E1@ksrmce.ac.in	Syed Mohammed Tahis
33	V. Prashanth	KSRMCE - Kadapa	6305643112	189Y1A04F6@ksrmce.ac.in	V. Prashanth
34	V.R.N. Sasank	KSRMCE - Kadapa	9110713221	189Y1A04F5@ksrmce.ac.in	V.R.N. Sasank
35	U. Siva Santosh	KSRMCE - Kadapa	6305547307	189Y1A04E6@ksrmce.ac.in	U. Siva Santosh

Coordinator

Resource Person

HOD

V. S. S. Mm/14
Principal
PRINCIPAL
K.S.R.M. COLLEGE OF ENGINEERING
KADAPA - 516 003. (A.P.)



K.S.R.M. COLLEGE OF ENGINEERING

(Autonomous)

Kadapa, Andhra Pradesh, India- 516 003

Approved by AICTE, New Delhi & Affiliated to JNTUA, Ananthapuramu.



KSNR

Since 1980

Certificate Of Participation

This Is To Certify That

Mr/Ms SHAIK MUNAZZAH FATIMA

*Has Attended The 2 - Day Ethical Hacking Workshop
Conducted By Algorithm Edu-Space,
Organised By ECE Dept, K.S.R.M College Of Engineering*

Date 23-10-21

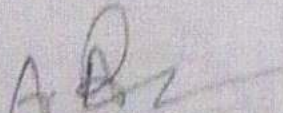
Signature Of The Instructor

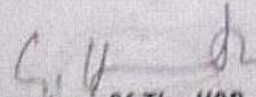
Signature Of The HOD

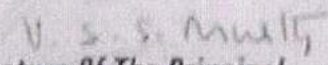
Signature Of The Principal
K.S.R.M. COLLEGE OF ENGINEERING
KADAPA - 516 003. (A.P.)



K.S.R.M. COLLEGE OF ENGINEERING

UGC - AUTONOMOUS

Approved by AICTE, New Delhi & Affiliated to JNTUA, Ananthapuramu.
Kadapa, Andhra Pradesh, India- 516 003



FEEDBACK FORM

Two - Day Workshop on "*Ethical Hacking*", 22nd and 23rd October, 2021

Organized

by

Department of Electronics & Communication Engineering

NAME: G. Maneesh Kumar Reddy
Dept: B.Sc.
College: SV Degree College
Mail Id: mahimaneesh33@gmail.com

S.No	Feedback Item	Excellent	Very Good	Good	Average	Below Average
1	Organization of workshop and session planning by instructor.	/				
2	Clarity in content delivery.		/			
3	Content is relevant and useful			/		
4	Adequate opportunity to interact with trainer		/			
5	Judicious mix of concepts. Principles and practices.			/		
6	Assignments and tasks are interesting and challenging.			/		
7	Overall rating			/		

Any suggestions for improvement.

G. Maneesh
Signature



K.S.R.M. COLLEGE OF ENGINEERING

UGC - AUTONOMOUS

Approved by AICTE, New Delhi & Affiliated to JNTUA, Ananthapuramu.
Kadapa, Andhra Pradesh, India- 516 003



FEEDBACK FORM

Two - Day Workshop on "*Ethical Hacking*", 22nd and 23rd October, 2021

Organized

by

Department of Electronics & Communication Engineering

NAME: B. Mani Kiran Reddy
Dept: ECE
College: Kanchi University
Mail Id: manikiranreddy2001@gmail.com

S.No	Feedback Item	Excellent	Very Good	Good	Average	Below Average
1	Organization of workshop and session planning by instructor.		✓			
2	Clarity in content delivery.	✓				
3	Content is relevant and useful		✓			
4	Adequate opportunity to interact with trainer			✓		
5	Judicious mix of concepts. Principles and practices.		✓			
6	Assignments and tasks are interesting and challenging.			✓		
7	Overall rating		✓			

Any suggestions for improvement.

Mani Kiran Reddy
Signature



K.S.R.M. COLLEGE OF ENGINEERING

UGC - AUTONOMOUS

Approved by AICTE, New Delhi & Affiliated to JNTUA, Ananthapuramu.
Kadapa, Andhra Pradesh, India- 516 003

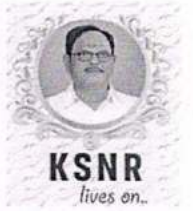

FEEDBACK FORM

Two - Day Workshop on "*Ethical Hacking*", 22nd and 23rd October, 2021

Organized

by

Department of Electronics & Communication Engineering

NAME: S. Sivakumari
Dept: ECE
College: KSRMCE Kadapa
Mail Id: 189YIA04E0@ksrmce.ac.in

S.No	Feedback Item	Excellent	Very Good	Good	Average	Below Average
1	Organization of workshop and session planning by instructor.			✓		
2	Clarity in content delivery.				✓	
3	Content is relevant and useful		✓			
4	Adequate opportunity to interact with trainer			✓		
5	Judicious mix of concepts. Principles and practices.		✓			
6	Assignments and tasks are interesting and challenging.			✓		
7	Overall rating			✓		

Any suggestions for improvement.

S. Sivakumari
Signature



K.S.R.M. COLLEGE OF ENGINEERING

UGC - AUTONOMOUS

Approved by AICTE, New Delhi & Affiliated to JNTUA, Ananthapuramu.
Kadapa, Andhra Pradesh, India- 516 003

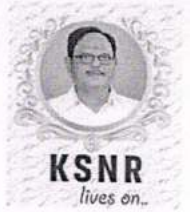

FEEDBACK FORM

Two - Day Workshop on "*Ethical Hacking*", 22nd and 23rd October, 2021

Organized

by

Department of Electronics & Communication Engineering

NAME: K.Sivamani

Dept: CSE

College: SV college of engineering

Mail Id: ksivamani1523@gmail.com

S.No	Feedback Item	Excellent	Very Good	Good	Average	Below Average
1	Organization of workshop and session planning by instructor.			✓		
2	Clarity in content delivery.		✓			
3	Content is relevant and useful		✓			
4	Adequate opportunity to interact with trainer			✓		
5	Judicious mix of concepts. Principles and practices.		✓			
6	Assignments and tasks are interesting and challenging.			✓		
7	Overall rating			✓		

Any suggestions for improvement.

K Sivamani
Signature



K.S.R.M. COLLEGE OF ENGINEERING

(AUTONOMOUS)

Kadapa, Andhra Pradesh, India- 516 003

Approved by AICTE, New Delhi & Affiliated to JNTUA, Ananthapuramu.

An ISO 14001:2004 & 9001: 2015 Certified Institution



KSNR
lives on.

Lr./KSRMCE/ (Department of E.C.E)/2021-22/

Date: **28.10.2021**

To

The Principal,
K.S.R.M.College of Engineering
Kadapa.

Respected Sir,

Sub:KSRMCE - (Department of E.C.E) -Subject – Requested - Reg.**Awareness program on Placements.**

It is being brought to your kind notice that, With reference to the cited, the department of Electronics & Communication engineering would like to conduct “**Awareness Program on Training and Placements**” on **01-11-2021**. The objective of this event is to encourage the students to prepare for the campus placements. As the coordinator, I would like to request your support and permission to conduct this event from 03.00 pm onwards in SJ 111 Seminar hall.

Thanking you, _

Yours Faithfully

Md. Mahaboob Pasha
Assistant Professor
Coordinator

*Forwarded to
the principal Sir
G. H. h.*

*Permitted
U. S. S. M. M. / G
28/10/2021*



K.S.R.M. COLLEGE OF ENGINEERING

(AUTONOMOUS)

Kadapa, Andhra Pradesh, India- 516 003

Approved by AICTE, New Delhi & Affiliated to JNTUA, Ananthapuramu.

An ISO 14001:2004 & 9001: 2015 Certified Institution

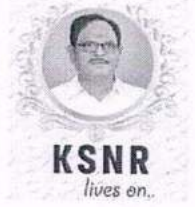

Cr./KSRMCE/Dept. of ECE/2021-22/

Date: 29-10-2021

CIRCULAR

It is hereby informed that “Awareness Program on Training and Placements” is going to be conducted by the department of ECE on 01-11-2021, from 03.00 pm onwards in SJ 111 Seminar hall. In this regard all the III year (V Sem) ECE students attend this program without fail.

HEAD OF THE DEPARTMENT

Cc to:

IQAC

KSRMCE



S.R.M. COLLEGE OF ENGINEERING

(AUTONOMOUS)

Kadapa, Andhra Pradesh, India- 516 003

Approved by AICTE, New Delhi & Affiliated to JNTUA, Ananthapuramu.

An ISO 14001:2004 & 9001: 2015 Certified Institution



ACTIVITY REPORT

"AWARENESS PROGRAM ON TRAINING AND PLACEMENTS"

1st November, 2021

- Target Group** : **V Sem Students**
- Co-coordinator(s)** : **MdMahaboob Pasha**
- Organizing Department** : **Electronics and Communication Engineering**
- Venue** : **Department Seminar Halls**

Description : To improve the number of placements in IT and Core Development companies an awareness program to V sem students was organized on 1st November 2021. VII sem students having good Technical and Communication skills from each department were invited to address the students and share their experiences and advice the students on how to prepare and be ready for their placements in 2022 - 23. Placement officer and Placement coordinators from each department also participated in this program. Program was organized department wise in their seminar halls. Senior students explained the need for attending placement trainings and importance of coding skills to crack jobs in MNC companies. In Mechanical and CIVIL Engineering departments senior students explained that IT companies recruit them also and these companies have projects related to their domains such as Automobiles, Electric Vehicles, Solar systems etc. Students expressed that with knowledge in their domains with minimum coding skills will easily be selected in IT companies for students belonging to these core branches. Students explained the importance of having a good communication skills and good resume while facing the interviews. Juniors were advised to utilize free resources available online for improving their technical knowledge.

Senior students accepted to support their juniors in preparing for their placements and help them in developing coding and soft skills.

List of VII sem (seniors) students participated in this program



/ksrmce.ac.in

Follow Us:



/ksrmceofficial

Roll Number	Name of the Student
189Y1A0454	K LAKSHMI SNEHA
189Y1A0464	K KIRAN
189Y1A0430	C SAINATH
189Y1A0488	M SAI SURYA
189Y1A0473	S SAI PRANAVARSHITHA
189Y1A0477	P GAYATHRI
189Y1A04A4	DIVYA MALIKA
189Y1A04D5	S KRISHNA TEJA
189Y1A04D6	SHREYA KAYANDE
199Y5A0403	GANGA MAMATHA

Photo

:

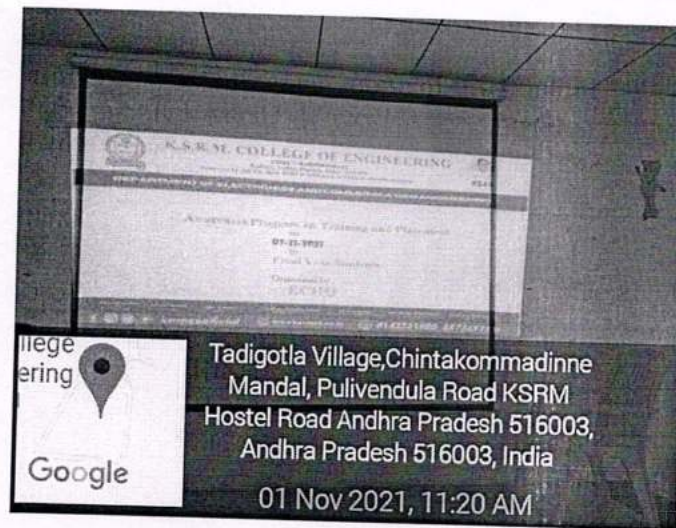

Fig. 1: Awareness Program Banner



Fig. 2: Dr. G. Hemalatha, HOD, addressing the students



Fig. 3: V Sem Students attended the awareness program



Fig. 4: Final Year students interacting with the V sem students

[Handwritten Signature]
Co-ordinator

[Handwritten Signature]
HOD

Department of ECE
AWARENESS PROGRAM ON TRAINING AND PLACEMENTS

Date: 01-11-2021

Sl. No	Roll Number	Name	Signature
1	199Y1A04G1	T. Ramarajasekhar	T. Ramarajasekhar
2	199Y1A04E3	S. Mohammed Ghouse	S. M. d Ghouse
3	209Y5A0410	L. Niharika	L. Niharika
4	209Y5A0413	M. V. haseeta	haseeta.v.M
5	209Y5A0416	Venkata lakshmi	Lakshmi
6	199Y1A04A0	M. Pavani	M. Pavani
7	199Y1A04B1	N. Maneesha	N. Maneesha
8	199Y1A04C0	P. Lingeswari	P. Lingeswari
9	199Y1A0489	M. sreevani	M. sreevani
10	199Y1A04D1	S. Lakshmi prasanna	S. prasanna
11	199Y1A0499	M. Navaneetha	M. Navaneetha
12	199Y1A0475	K. Neha	K. Neha
13	199Y1A04D3	V. charitha	V. charitha
14	199Y1A04B0	N. Jyothika	Jyothika
15	199Y1A04C8	R. keesathana	R. keesathana
16	199Y1A0477	K. Archana	Archana
17	199Y1A04B3	P. Bhramika	Bhramika
18	199Y1A04A9	N. poornima	Poornima
19	199Y1A04A6	M. Sravanthi	Sravanthi
20	199Y1A0474	K. srividhya	Srividhya
21	199Y1A0493	M. Sudhasrani	M. Sudhasrani
22	199Y1A04C6	P. Naveena	P. Naveena

Sl. No	Roll Number	Name	Signature
23.	199Y1A04A5 M. Pranitha	M. Pranitha	M. Pranitha
24.	199Y1A04B8	P. Sumathi	P. Sumathi
25.	199Y1A0469	K. Prasanthi	K. Prathi
26.	199Y1A0496	M.V. Manisha	mvmmanisha
27.	199Y1A04A3	M. Ruchitha	M. Ruchitha
28.	199Y1A0473	K. Eeshitha Rachana	K. Eeshitha
29.	199Y1A04C5	P. Geetha Reddy	P. Geetha Reddy
30.	199Y1A0472	K. Prathyusha	K. Prathyusha
31.	199Y1A04C1	P. Thulasi sree	P. Thulasi sree
32.	199Y1A04C7	R. Niharika	R. Niharika
33.	199Y1A04D5	S. Sudheer Reddy	S. Sudheer
34.	199Y1A04E0	S. Jeevan	S. Jeevan
35.	199Y1A0479	K. Venkatesh	K. Venkatesh
36.	199Y1A04B5	P. Vamsi	P. Vamsi
37.	199Y1A0470	K. Lakshmi Narayana	K. Nari/
38.	199Y1A0476	K. Chandra sekhar Reddy	K. Chand
39.	199Y1A0484	K. Sai Prakash	K. Sai Prakash
40.	199Y1A0487	M. Sai vardhan reddy	M. Sai vardhan
41.	199Y1A0497	M. Gangadhar Reddy	M. Gangadhar
42.	199Y1A0498	M. Gowtham	M. Gowtham
43.	199Y1A04D6	S. Sai kumar Reddy	S. Sai kumar
44.	199Y1A04D2	SAI KRISHNA. K	Sai Krishna
45.	199Y1A0486	L. Rupesh babu	L. Rupesh babu
46.	199Y1A04C2	P. Sai prajwal	P. Sai prajwal
47.	199Y1A04A8	N. Brahman	Brahman

Sl. No.	Roll Number	Name	Signature
48	199Y1A04D7	Shaik Froz	Shaik Froz
49	199Y1A0488	M.V. Sainath Reddy	M.V. Sainath.
50	199Y1A0495	M. Chandra Selchar	M. Chandra Selchar
51	199Y1A0480	K.B. Yessuri Swamy	K.B. Yessuri Swamy
52	199Y1A04B2	N. Sainath	N. Sainath
53	199Y1A0483	K. Lakshmananna	K. Lakshmananna
54	199Y1A0497	M. Gangadhar Reddy	M. Gangadhar Reddy
55	199Y1A04A2	M. Gnaneswar. Reddy	M. Gnaneswar Reddy
56	199Y1A04D9	S. Javeed	S. Javeed
57	199Y1A04D0	S.K. Siva Charan Reddy	S.K. Siva Charan Reddy
58	199Y1A04C4	P.S. Koushik	P.S. Koushik



K.S.R.M. COLLEGE OF ENGINEERING

(UGC-AUTONOMOUS)

Kadapa, Andhra Pradesh, India- 516 003

Approved by AICTE, New Delhi & Affiliated to JNTUA, Ananthapuramu.

An ISO 14001:2004 & 9001: 2015 Certified Institution



Date: 25.11.2021

To

The Principal,
K.S.R.M.College of Engineering,
Kadapa.

58

Respected Sir,

Sub: KSRMCE - (Civil Engineering Department) Permission to conduct a guest lecture on “Utilization of Drones in Modern Surveying” – Req –Reg.

It is being brought to your kind notice that, With reference to the subject cited, the Civil Engineering Department is planning to conduct a guest lecture on “Utilization of Drones in Modern Surveying” for IV B.Tech students on 26th November 2021 in Online mode from 4-5 pm. In this regard I kindly request you to grant permission to conduct the guest lecture.

Thanking you Sir,

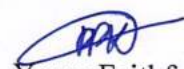
Yours Faithfully

P.Pavan Kumar,

Asst. prof in Civil dept.

Forwarded to
Principal Sir

UPL
25/11/21

Permitted
U. S. S. Murthy
25/11/2021



K.S.R.M. COLLEGE OF ENGINEERING

(UGC-AUTONOMOUS)

Kadapa, Andhra Pradesh, India- 516 003

Approved by AICTE, New Delhi & Affiliated to JNTUA, Ananthapuramu.

An ISO 14001:2004 & 9001: 2015 Certified Institution



25-11-2021

Circular

All the IV Year B. Tech students are here by informed that Department of Civil Engineering is going to conduct A guest lecture on “**Utilization of Drones in Modern Surveying**” on 26th November 2021 in Online mode from 4-5 pm. Interested students may register their names with the following link before 25th November 2021.

Resource Person:

Mr. Gokul Selwa
Survey Engineer
Aries Marine and Engineering Services
Coimbatore

Registration Link:

https://docs.google.com/forms/d/156_RfZfa0QpOmUl3iKe7fcRRewfuB4h8IKAPkXbf9Bk/edit

For any queries Contact,

Coordinators

Mr.P.Pavan Kumar, Assistant Professor in CED

Ms.V.Sai Neeraja, Assistant Professor in CED

V. S. S. Murali
26/11/21
26/11/21
V. S. S. Murali

V. S. S. Murali
Principal
PRINCIPAL
K.S.R.M. COLLEGE OF ENGINEERING
KADAPA - 516 003. (A.P.)

 /ksrmce.ac.in

Follow Us:



/ksrmceofficial



K.S.R.M. COLLEGE OF ENGINEERING

(AUTONOMOUS)

Kadapa, Andhra Pradesh, India- 516 003

Approved by AICTE, New Delhi & Affiliated to JNTUA, Ananthapuramu.

An ISO 14001:2004 & 9001: 2015 Certified Institution



ACTIVITY REPORT

Guest Lecture

"Utilization of Drones in Modern surveying"

26th November, 2021

Name of the Activity	<i>"Utilization of Drones in Modern surveying"</i>	
Type of Activity	Guest Lecture	
Date and Time of Activity	26-11-2021	04.00 pm to 06.00 pm
Details of Participants	Final Year VII SEM Students-56 Students	
Coordinator(s)	P. Pavan Kumar ,V Sai Neeraja	
Organizing Dept./Support System	Civil Engineering	
Description	The speakers MR. Gokul Selva explained the about topic, agenda and its contents. The session is concentrated on Utilization of Drones in Modern Surveying. The speaker explained about Drones, its origin, uses and applications. Explained in detail about demanding of drones in world in Civil Engineering, Telecom Services, Bridge inspection, marine inspection etc. And also explained more detail about Thermal and general Inspection by using Drones where there is no access by the human being. The Future scope of drones in industry requirements, Updating the prevailing and invention based on requirement was explained. The Students are interacted with Speaker and clarified their doubts. Finally, Miss V. Sai Neeraja (Co- coordinator of event) delivered vote of	

their active participation. Especially very thanks to the HoD Sir, Principal Sir and K.S.R.M. College Management for giving opportunity to the Department to organize this kind of Guest Lecture.

Photos

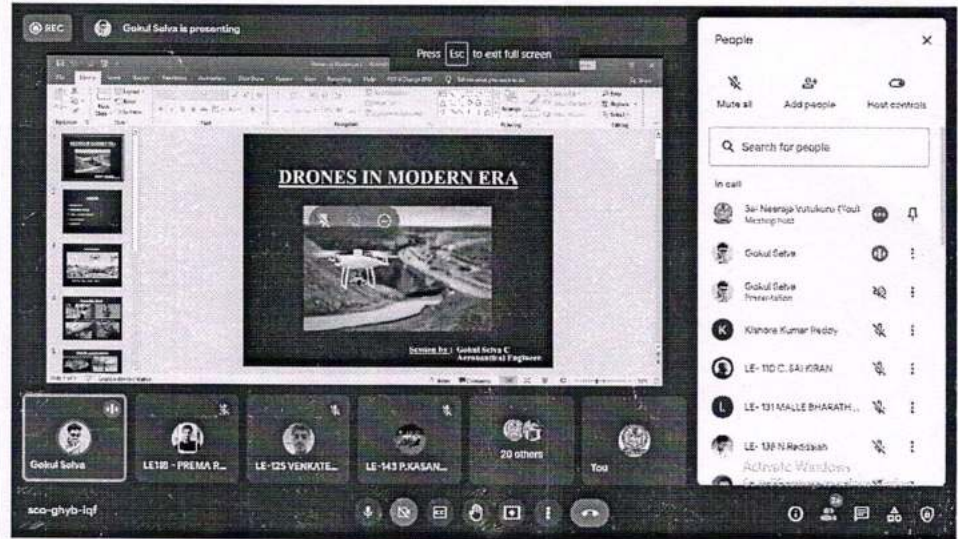

Drone in modern era



Drone importance

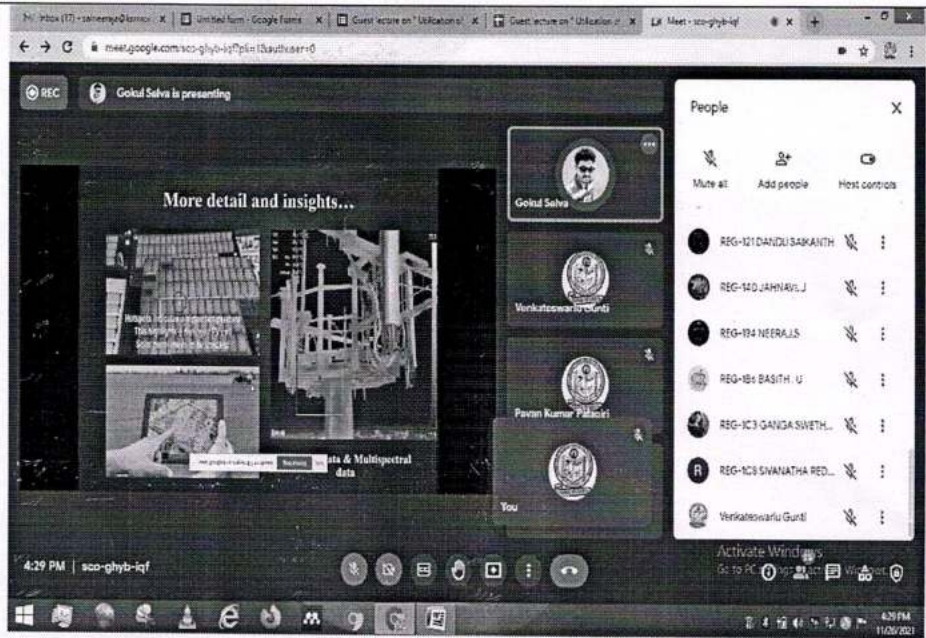

Drone in various fields

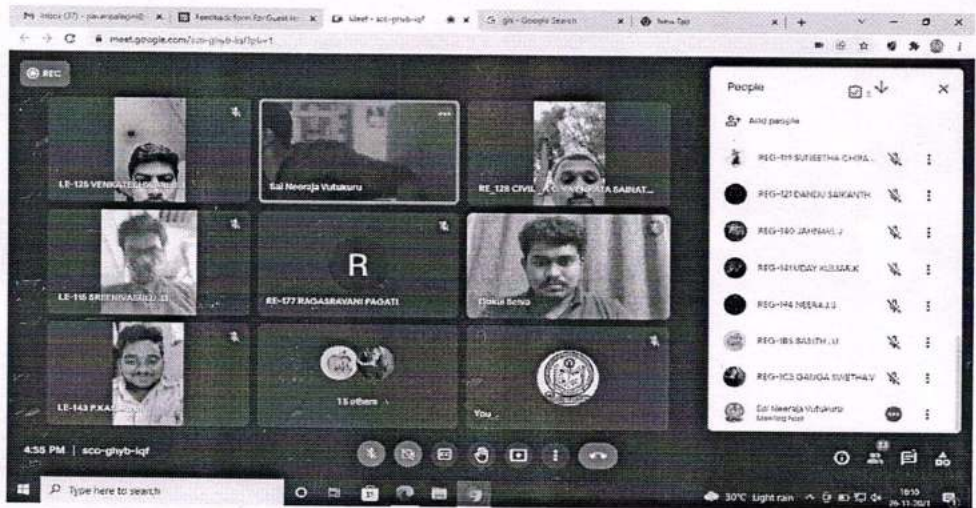

Virtual Screenshot of participants and trainer

Co-ordinator

V. S. S. MULLA
Principal

PRINCIPAL
K.S.R.M. COLLEGE OF ENGINEERING
KADAPA - 516 003. (A.P.)



K.S.R.M. COLLEGE OF ENGINEERING (UGC-AUTONOMOUS)

Kadapa, Andhra Pradesh, India- 516 003

Approved by AICTE, New Delhi & Affiliated to JNTUA, Ananthapuramu

DEPARTMENT OF CIVIL ENGINEERING



KSNR
lives on..



Guest lecture

on

Utilization of Drones in Modern Surveying

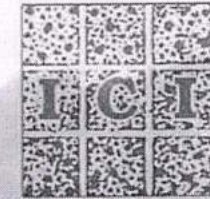

Resource person

Sri M Gokul Selwa
Survey Engineer
Aries Marine & Engineering services
Coimbatore, Tamil Nadu

Coordinator: Sri P Pavan Kumar, Asst. Professor
Co-coordinator: Miss V Sai Neeraja, Asst. Professor

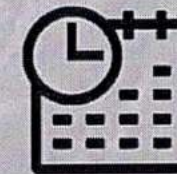

26-11-2021

04.00 PM -

06.00 PM

Virtual Mode



Dr. N Amaranatha Reddy
HOD

Dr. V S S Murthy
Principal

Prof. A Mohan
Director

Dr. K Chandra Obul Reddy
Managing Director

Smt. K Rajeswari
Correspondent Secretary,
Treasurer

Sri K Madan Mohan Reddy
Vice Chairman

Sri K Raja Mohan Reddy
Chairman



K.S.R.M. COLLEGE OF ENGINEERING

(UGC-AUTONOMOUS)

Kadapa, Andhra Pradesh, India- 516 003

Approved by AICTE, New Delhi & Affiliated to JNTUA, Ananthapuramu.

An ISO 14001:2004 & 9001: 2015 Certified Institution



Department of Civil Engineering

Name of the Event: "Utilization of Drones in Modern Surveying"

List of Participants

S.NO.	Roll No.	Name of the student	Branch	Signature
1	189Y1A0121	D.SAI KANTH	Civil	Saikanth
2	189y1a0128	G Y VENKATA SAINATH REDDY	Civil	Sainath
3	189Y1A0137	JAMALLA GANGARAJU	Civil	Gangaraju
4	189Y1A0158	M.LOKESHWAR REDDY	Civil	Lokesh
5	189y1a0161	M.sai karthik	Civil	Karthik
6	189y1a0109	B. Rama chandra reddy	Civil	Ramachandra
7	189Y1A0156	MAADAM SUDHEER KUMAR	Civil	Sudheer
8	189Y1A0129	GADDAM ARAVINDA Reddy	Civil	Aravinda
9	189y1a0119	Chirasani suneetha	Civil	Suneetha
10	189Y1A0142	Kalluri Venkata Sachin Reddy	Civil	Sachin
11	189Y1A0133	Guduru Ajay Kumar	Civil	Ajay
12	189Y1A0144	KANNAPU BHANUMANIKANTA REDDY	Civil	Bhanu
13	189Y1A0140	J. Jahnavi	Civil	Jahnavi
14	189Y1A0159	Ganesh Mandla	Civil	Ganesh
15	189y1a0141	Kaipu Uday Kumar	Civil	Uday
16	189y1a0153	L Venkataiah	Civil	Venkataiah
17	189Y1A0148	K.Sunil Kumar	Civil	Sunil
18	189y1a0145	Karnati Saimallikarjunareddy	Civil	Karnati
19	189y1a0114	Challa Jithendra Reddy	Civil	Jithendra
20	189Y1A0120	C.Anil Kumar	Civil	Anil
21	189Y1A0117	CHILAMAKURU VENKATA MOHAN	Civil	Mohan
22	189Y1A0181	P.munikumar	Civil	Munika
23	189Y1A0187	Penubala Rakesh Prasanna	Civil	Rakesh
24	189Y1A01C3	Vennapusa Ganga Swetha	Civil	Ganga Swetha
25	189Y1A0166	Mitta Siva Prasad Reddy	Civil	Siva Prasad
26	189Y1A0185	Praveen Patil	Civil	Praveen
27	189Y1A0163	Sampath Kumar Meka	Civil	Sampath
28	189Y1A0174	Nallanukala Mahesh	Civil	Mahesh
29	189Y1A01A9	T Arun Kumar reddy	Civil	Arun
30	189Y1A01B6	Basith UDAYAGIRI	Civil	Basith
31	189Y1A01B2	T.siva reddy	Civil	Siva
32	189Y1A0175	Abhish Nanubala	Civil	Abhish
33	189Y1A0177	PAGATI RAGA SRAVANI	Civil	Raga
34	189y1a01b5	T.Dasthagiri	Civil	Dasthagiri
35	189Y1A01C8	Y.Sivanatha Reddy	Civil	Sivanatha
36	189Y1A0191	PAVANKALYAN POMAR	Civil	Pavan
37	189Y1A0189	P.NAGA SAI	Civil	Naga Sai
38	189Y1A0194	S.Neeraj	Civil	Neeraj
39	189Y1A01C0	V.K.NARAHARI NATH REDDY	Civil	Narahari

40	189Y1A01C0	V.K.NARAHARI NATH REDDY	Civil	<i>nath</i>
41	199Y5A0127	KASHETTY VENKATESWARLU	Civil	<i>Venken</i>
42	199Y5A0117	DUDEKULA DASTAGIRI	Civil	<i>Dastagir</i>
43	199Y5A0138	Nagulugari Reddaiah	Civil	<i>Reddaiah</i>
44	199Y5A0159	T.CHANDU	Civil	<i>Chandu</i>
45	199Y5A0107	B vijay kumar reddy	Civil	<i>Vijay</i>
46	199y5a0110	C.Saikiran	Civil	<i>Saikiran</i>
47	199Y5A0111	CHINNA SWAMI GARI ROHITH	Civil	<i>Rohith</i>
48	199y5a0131	MALLE BHARATH VENKATA SAI	Civil	<i>Bharath</i>
49	199y5a0104	ANGALAGUTHI SOMASEKHAR	Civil	<i>Sai</i>
50	199Y5A0108	Bonthalapalli Sai	Civil	<i>Sai</i>
51	199y5a0155	Sirigiri Sravani	Civil	<i>Sravani</i>
52	199Y5A0123	Gosetty ramu	Civil	<i>Ramu</i>
53	199Y5A0115	Dasari sreenivasulu	Civil	<i>Sreenivasulu</i>
54	199Y5A0128	KUNUKUNTLA VISWANATH	Civil	<i>Viswanath</i>
55	199Y5A0148	PYDIKALVA VAMSI KUMAR	Civil	<i>Vamsi</i>
56	199Y5A0145	PATURU PREMCHAND	Civil	<i>Premchand</i>
57	199y5a0162	V VENKATA SREENADH	Civil	<i>Sreenadh</i>
58	199Y5A0112	CHINTHAKUNTA MAHESH BABU	Civil	<i>Mahesh</i>
59	199Y5A0158	T. Pradeep reddy	Civil	<i>Pradeep</i>
60	199Y5A0147	P. VENKATA KRISHNA	Civil	<i>Venkate</i>
61	199Y5A0118	E.PREMARAJU	Civil	<i>Prem Raju</i>
62	199y5a0143	Pandeeti kasanna	Civil	<i>Kasanna</i>

PPW
Co-ordinator

YPL
HOD

V. S. S. Mm 14
Principal

Head
Department of Civil Engineering
K.S.R.M. College of Engineering
(Autonomous)
KADAPA 516 003. (A.P.)

PRINCIPAL
K.S.R.M. COLLEGE OF ENGINEERING
KADAPA - 516 003. (A.P.)



K.S.R.M. COLLEGE OF ENGINEERING

(UGC-AUTONOMOUS)

Kadapa, Andhra Pradesh, India- 516 003

Approved by AICTE, New Delhi & Affiliated to JNTUA, Ananthapuramu.

An ISO 14001:2004 & 9001: 2015 Certified Institution

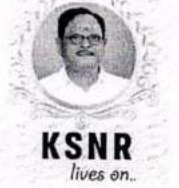

Lr./KSRMCE/ (Department of E.C.E)/2020-21/

Date: **03.12.2020**

To

The Principal,
K. S. R. M. College of Engineering
Kadapa.

Respected Sir,

Sub: KSRMCE - (Department of E.C.E) - Subject - Requested - Reg. conducting a Workshop for students.

It is being brought to your kind notice that, With reference to the cited, the department of Electronics & Communication engineering would like to organize a two-day workshop on "Digital System Design using Verilog HDL Part-I" from 10-12-2020 to 11-12-2020. The participants will be from third year ECE. The objective of this workshop is to introduce differences between VHDL and Verilog; Designing of Combinational logic circuits using Verilog coding. As a coordinator, I would kindly request your support and permission to conduct this workshop in virtual mode (Google Meet) from 10.00 AM to 4.00 PM.

Thanking you

Yours Faithfully

Sri R.V. Sreehari

Associate Professor/ECE
Coordinator

Cc:

To The Director for Information

To All Deans /HoD's

*Forwarded to the
Principal Sir
G. H.*

*Permitted
U. S. S. Muelly*

The Management / Director /Deans/HoDs/IQAC for information



K.S.R.M. COLLEGE OF ENGINEERING
(UGC-AUTONOMOUS)

Kadapa, Andhra Pradesh, India- 516 003



Approved by AICTE, New Delhi & Affiliated to JNTUA, Ananthapuramu.

An ISO 14001:2004 & 9001: 2015 Certified Institution

Cr./KSRMCE/ (Department of E.C.E)/2020-21/

Date: 07-12-2020

Circular

It is hereby informed that **A Two Day Online Workshop on “Digital System Design using Verilog HDL Part-I”** is going to be organized by the department of E.C.E on **10-11 December, 2020** from 9.30 AM to 4.30 PM through virtual mode (Google Meet).

Google Meet link: <https://meet.google.com/bvc-ckrv-asr>





In this connection, all the third year ECE students and faculty are hereby directed to attend the workshop without fail.

V. S. S. Muelg
Principal

PRINCIPAL
K.S.R.M. COLLEGE OF ENGINEERING
KADAPA-516003. (A.P.)

Cc to:

The Management / Director /Deans/HoDs/IQAC for information

 /ksrmce.ac.in Follow Us:    /ksrmceofficial



K.S.R.M. COLLEGE OF ENGINEERING

(AUTONOMOUS)

Kadapa, Andhra Pradesh, India- 516 003

ACTIVITY REPORT

A Two day online workshop

On

"Digital System Design using Verilog HDL Part-I"

10-11 December 2020

Target Group	:	III year ECE students
Details of Participants	:	28 students
Resource person	:	Sri R.V. Sreehari, Smt. S. Sharmila Banu
Organizing Department	:	Electronics and Communication Engineering
Venue	:	Virtually through Google meet

Description: The topics covered during the workshop

1. Introduction
2. Difference between VHDL and Verilog
3. Basics of Verilog
4. Verilog coding levels
5. Design of Combinational logic circuits.

Photo

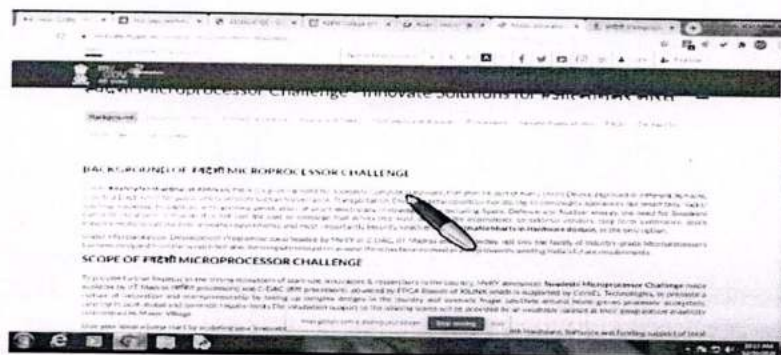

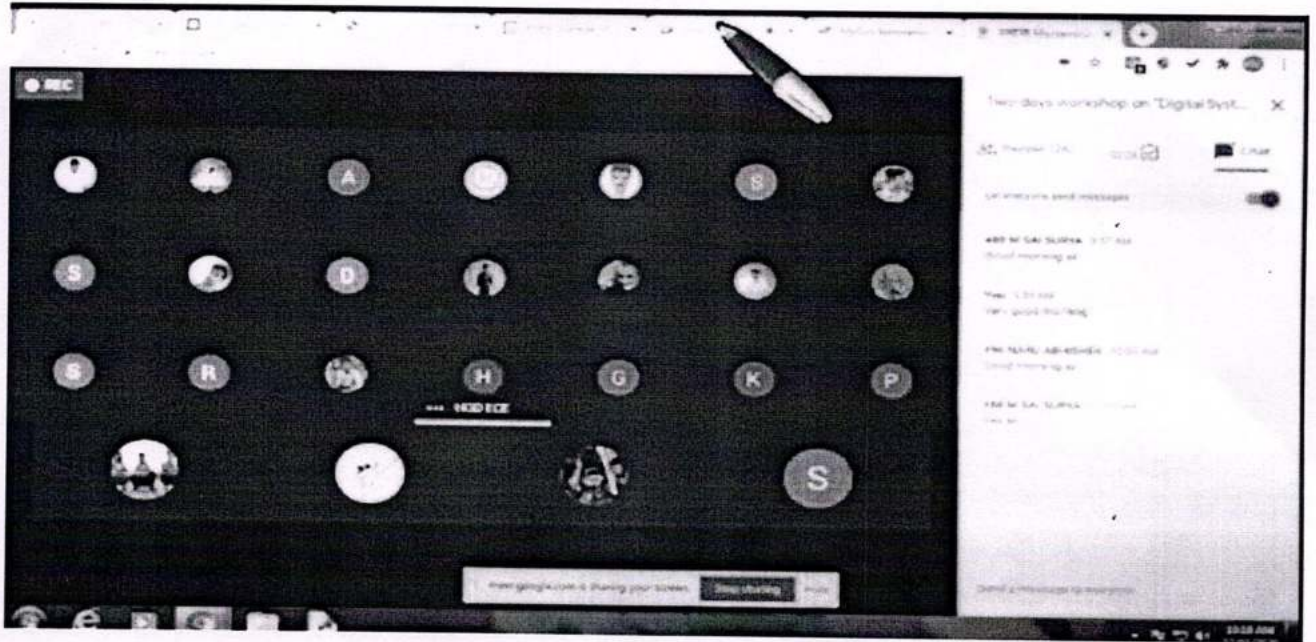

Verilog code for AND gate using behavioral modeling

```
module AND_2_behavioral (output reg Y, input A, B);
    always @* (A or B) begin
        if (A == 1'b1 & B == 1'b1) begin
            Y = 1'b1;
        end
        else
            Y = 1'b0;
        end
    end
endmodule
```

Coordinator

HOD

Principal

PRINCIPAL
K.S.R.M. COLLEGE OF ENGINEERING
KADAPA-516003. (A.P.)



K.S.R.M. COLLEGE OF ENGINEERING

(UGC-AUTONOMOUS)

Kadapa, Andhra Pradesh, India- 516 003

Approved by AICTE, New Delhi & Affiliated to JNTUA, Ananthapuramu.

An ISO 14001:2004 & 9001: 2015 Certified Institution



Date: 10-12-2020

Name of the Event: Workshop on "Digital System Design using Verilog HDL Part-I"

Venue : Virtually through Google meet

List of Participants

S. No	Name	Department	Roll No	Email Id
1	SHAIK ARSHEEN	E.C.E	189Y1A04C7	189Y1A04C7@ksrmce.ac.in
2	S. GUNA VIKESH	E.C.E	189Y1A04C3	189Y1A04C3@ksrmce.ac.in
3	B. JAGADEESH	E.C.E	189Y1A0411	189Y1A0411@ksrmce.ac.in
4	BOMMIREDDY LAKSHMI PRASANNA (W)	E.C.E	189Y1A0418	189Y1A0418@ksrmce.ac.in
5	DASARI SIVANI	E.C.E	189Y1A0431	189Y1A0431@ksrmce.ac.in
6	C. SAINATH	E.C.E	189Y1A0430	189Y1A0430@ksrmce.ac.in
7	G. JYOTHIRMAYEE SAI PRASANNA	E.C.E	189Y1A0444	189Y1A0444@ksrmce.ac.in
8	K. SIRI VENNELA	E.C.E	189Y1A0460	189Y1A0460@ksrmce.ac.in
9	GANGIREDDYDEEPIKA	E.C.E	189Y1A0441	189Y1A0441@ksrmce.ac.in
10	GANGIREDDY VAMSI KRISHNA REDDY	E.C.E	189Y1A0440	189Y1A0440@ksrmce.ac.in
11	G. RAHUL	E.C.E	189Y1A0443	189Y1A0443@ksrmce.ac.in
12	KADIRI LAKSHMI SNEHA	E.C.E	189Y1A0454	189Y1A0454@ksrmce.ac.in
13	DEPATLA VINAY KUMAR	E.C.E	199Y5A0406	199Y5A0406@ksrmce.ac.in
14	G VIJAYA NARASIMHA REDDY	E.C.E	199Y5A0407	199Y5A0407@ksrmce.ac.in
15	K. MADHUMOHAN	E.C.E	189Y1A0455	189Y1A0455@ksrmce.ac.in
16	K. VINAY KUMAR	E.C.E	189Y1A0453	189Y1A0453@ksrmce.ac.in
17	D. SURESH	E.C.E	189Y1A0433	189Y1A0433@ksrmce.ac.in
18	K. ARSHAD	E.C.E	189Y1A0456	189Y1A0456@ksrmce.ac.in
19	K. MANJULA	E.C.E	189Y1A0472	189Y1A0472@ksrmce.ac.in
20	KONGANI KIRAN	E.C.E	189Y1A0464	189Y1A0464@ksrmce.ac.in
21	M. HARIHARA NANDAN	E.C.E	189Y1A0476	189Y1A0476@ksrmce.ac.in
22	M. SAI KRISHNA	E.C.E	189Y1A0474	189Y1A0474@ksrmce.ac.in
23	P. HIMA BINDU	E.C.E	189Y1A04A5	189Y1A04A5@ksrmce.ac.in
24	P. GAYATHRI DEVI	E.C.E	189Y1A04A4	189Y1A04A4@ksrmce.ac.in
25	N. ABHISHEK	E.C.E	189Y1A0496	189Y1A0496@ksrmce.ac.in
26	M. SAI SURYA	E.C.E	189Y1A0488	189Y1A0488@ksrmce.ac.in
27	M. REVATHI	E.C.E	189Y1A0487	189Y1A0487@ksrmce.ac.in
28	L. SAI PRANAVARSHITHA	E.C.E	189Y1A0473	189Y1A0473@ksrmce.ac.in

Co-ordinator

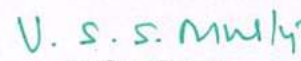
Principal

 /ksrmce.ac.in

Follow Us:

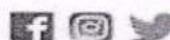

PRINCIPAL
K.S.R.M. COLLEGE OF ENGINEERING
KADAPA-516003. (A.P.)



K.S.R.M. COLLEGE OF ENGINEERING (Autonomous), Kadapa.

(Approved by AICTE, Accredited by NAAC, Affiliated to JNTUA, Ananthapuramu.)

(An ISO 9001:2015 Certified Institution)



This is to certify that ~~Kongani Kiran~~ of KSRMCE (A), KADAPA has attended A Two-days workshop on “Digital System Design using Verilog HDL-Part I” during 10th & 11th December 2020, organized by the Department of ECE, K.S.R.M. College of Engineering (Autonomous), Kadapa.

Prof. G. Hemalatha
HOD-ECE

Prof. V.S.S. Murthy
Principal

Prof. A. Mohan
Director



K.S.R.M. COLLEGE OF ENGINEERING

(UGC-AUTONOMOUS)

Kadapa, Andhra Pradesh, India- 516 003

Approved by AICTE, New Delhi & Affiliated to JNTUA, Ananthapuramu.

An ISO 14001:2004 & 9001: 2015 Certified Institution



Cr./KSRMCE/(Dept. of ME)/2020-21/

Date: 11-12-2020

To

The principal,
K.S.R.M College of Engineering,
Kadapa.

Sub: KSRMCE – (Department of Mechanical Eng.)-Permission to conduct Guest lecture on 'Awareness for Mechanical Students 'Requested-Reg..

---***---

//THROUGH PROPER CHANNEL//

Respected sir,

It is being brought to your kind notice that, With Reference to the cited, the Department of Mechanical Engineering is Planning to Organize Virtual Guest lecture on 'Awareness for Mechanical Students 'on 14th Dec 2021 in off-line Mode. In this Regard I Kindly request you to grant Permission to conduct Guest Lecture, For which kind of Act. I Would be Grateful to you sir.

Thanking you sir,

Yours Faithfully

S. vijaya Kumar.Coordinatar

Asst Prof.in MED,.K.S.R.M CE

Forwarded to the
Principal Sir
L.S. Janna

Permitted
V. S. S. Murthy



K.S.R.M. COLLEGE OF ENGINEERING

(UGC-AUTONOMOUS)

Kadapa, Andhra Pradesh, India- 516 003

Approved by AICTE, New Delhi & Affiliated to JNTUA, Ananthapuramu.

An ISO 14001:2004 & 9001: 2015 Certified Institution



Cr./KSRMCE/(Dept./ME)/2020-21/

Date:11-12-2020

Circular

All B. Tech Students are here by informed that Department of Mechanical Engineering is going to Organize Virtual Guest Lecture on 'Awareness For Mechanical Students 'on 14thDec.2020.All the B. Tech III Sem Mechanical Students May Register Your names with Coordinator Sri.S. Vijaya Kumar, Asst.Professor, Dept. Of Mechanical Engineering, K.S.R.M College of Engineering

CC to :

The HOD, Department of Mechanical, K.S.R.M.C.E

IQAC, K.S.R.M.C.E

III semester students

Coordinator

HOD

Professor & head
Department of Mechanical Engineering
K.S.R.M. College of Engineering
KADAPA - 516 003.



K.S.R.M. COLLEGE OF ENGINEERING

(AUTONOMOUS)

Kadapa, Andhra Pradesh, India- 516 003

Approved by AICTE, New Delhi & Affiliated to JNTUA, Ananthapuramu.

An ISO 14001:2004 & 9001: 2015 Certified Institution



ACTIVITY REPORT

Guest Lecture

On

"Awareness for Mechanical Students"

14th Dec, 2020

Target Group : B Tech III Sem Mechanical students

Details of Participants : 104 Students, III Sem A&B Sec.

Co-Ordinator : S. vijaya Kumar Asst. Professor.

Organizing Department : Department of Mechanical Eng.

Venue : Off line Mode (Mechanical Seminar Hall)

Description : A virtual Guest Lecture on "Awareness for Mechanical Students" was organized by the Department of Mechanical Engineering, KSRMCE, Kadapa on 14th, 2020 from 2 Pm to :3 pm. The aim of the Guest lecture was to bring the Imartaence of **How to Face Competitive Exams To get Govt Jobs** . He Delivered the need of Desire, Passion on Govt Jobs for getting it, The chief guest of the program was sri.B.Venkata Ramana Naik, Assistant Motor Vehicle Inspector. He gave lots of information for The Mechanical Engineering students to get Plenty of Opportunities in Public Sectors. The Principal of K.S.R.MCE Dr. V.S.S. Murthy Garu Advised the students to Do the Hard Work to Achieve this Govt.Jobs for their betterment in life. Dr.D. Ravikhanth Garu, HOD, coordinator of the Guest Lecture, addressed the students to follow the Advises to get fruitful life in yours Carrier as a Mechanical Engineer in Public Sectors . The Guest Lecture was successful with the presence of the above dignitaries, over 70no.of students are participation. The Guest Lecture was ended with the vote of thanks by Sri.K.Suresh kumar Associate Professor of the program.



K.S.R.M. COLLEGE OF ENGINEERING

(AUTONOMOUS)

Kadapa, Andhra Pradesh, India- 516 003

Approved by AICTE, New Delhi & Affiliated to JNTUA, Ananthapuramu.

An ISO 14001:2004 & 9001: 2015 Certified Institution



Photos



Felicitation to Motor vehicle Inspector Sri. Venkata Ramana Naik by HOD Dr.D. Ravikanth and senior professors



K.S.R.M. COLLEGE OF ENGINEER

(AUTONOMOUS)

Kadapa, Andhra Pradesh, India- 516 003

Approved by AICTE, New Delhi & Affiliated to JNTUA, Ananthapuramu.

An ISO 14001:2004 & 9001: 2015 Certified Institution

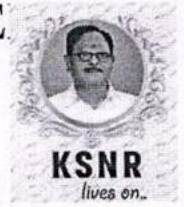

Faculty and students attending the Awareness program

Coordinator

HOD

Professor & head
Department of Mechanical Engineering
K.S.R.M. College of Engineering
KADAPA - 516 003.

/ksrmce.ac.in

Follow Us:



/ksrmceofficial



K.S.R.M. COLLEGE OF ENGINEERING

(UGC - Autonomous)

Kadapa, Andhra Pradesh, India- 516 003

Approved by AICTE, New Delhi & Affiliated to JNTUA, Ananthapuramu.



KSNR
lives on.

DEPARTMENT OF MECHANICAL ENGINEERING

Gust Lecture

“Awareness for Mechanical Students”



Dept. Of Mechanical Seminar Hall,



14-12-2020

This Guest Lecture was for B Tech III Sem Mechanical Students

Coordinator

Sri S. vijaya Kumar.
Asst. Professor in MED

Resource Person

Sri Venkata Ramana Naik
Assistant Motor Vehicle Inspector.
Kadapa

Organized by

Department of
Mechanical Engineering

PROF. D. RAVIKANTH
HOD

DR. V.S.S. MURTHY
DPMC cell

PROF. A. MOHAN
Director

DR. K. CHANDRA OBUL REDDY
Managing Director

SMT. K. RAJESWARI
(Correspondent, Secretary, Treasurer)

SRI K. MADAN MOHAN REDDY
Vice-Chairman

SRI K. RAJA MOHAN REDDY
Chairman

f @ > [ksrmceofficial](#)

www.ksrmce.ac.in

☎ 8143731980, 8575697569

Registration link for Guest Lecture on 'Awareness for Mechanical Students'

By Department of Mechanical engineering Dept., KSRMCE

* Required

1. Email *

2. Name of the student *

3. Year & Semester *

4. Branch *

5. Roll Number *

6. Address for Communication *

K.S.R.M College of Engineering (Autonomous), Kadapa

Department of Mechanical Engineering

**Registration form on Guest lecture on
'Awareness for Mechanical Students'**

email	Name of the student	Year & Semester	Branch	Roll Number	Address for communication
199Y5A0311@ksrmce.ac.in	GUNTHA MANI SAGAR	II/III	MECH	199Y5A0311	K.S.R.M. COLLEGE OF ENGINEERING, KADAPA
199Y5A0323@ksrmce.ac.in	MAKAM JOSHUA	II/III	MECH	199Y5A0323	K.S.R.M. COLLEGE OF ENGINEERING, KADAPA
199Y1A0301@ksrmce.ac.in	AKULA SREEDHAR	II/III	MECH	199Y1A0301	K.S.R.M. COLLEGE OF ENGINEERING, KADAPA
199Y1A0302@ksrmce.ac.in	B SRINIDHI SAI	II/III	MECH	199Y1A0302	K.S.R.M. COLLEGE OF ENGINEERING, KADAPA
199Y1A0303@ksrmce.ac.in	BANDI SHIVA REDDY	II/III	MECH	199Y1A0303	K.S.R.M. COLLEGE OF ENGINEERING, KADAPA
199Y1A0304@ksrmce.ac.in	CHAGANTI SUNIL KUMAR REDDY	II/III	MECH	199Y1A0304	K.S.R.M. COLLEGE OF ENGINEERING, KADAPA
199Y1A0305@ksrmce.ac.in	CHEPPALI AMATHYA	II/III	MECH	199Y1A0305	K.S.R.M. COLLEGE OF ENGINEERING, KADAPA
199Y1A0306@ksrmce.ac.in	CHIRUCHAPALA ABDUL SUBAHAN	II/III	MECH	199Y1A0306	K.S.R.M. COLLEGE OF ENGINEERING, KADAPA
199Y1A0307@ksrmce.ac.in	DEVAPATLA BHARATH SIMHA REDDY	II/III	MECH	199Y1A0307	K.S.R.M. COLLEGE OF ENGINEERING, KADAPA
199Y1A0308@ksrmce.ac.in	DUDIMANI SAI SRUJAN KUMAR	II/III	MECH	199Y1A0308	K.S.R.M. COLLEGE OF ENGINEERING, KADAPA
199Y1A0309@ksrmce.ac.in	GADIKOTA MURALIDHAR REDDY	II/III	MECH	199Y1A0309	K.S.R.M. COLLEGE OF ENGINEERING, KADAPA
199Y1A0310@ksrmce.ac.in	GANGALA VENKATA PRATHAP	II/III	MECH	199Y1A0310	K.S.R.M. COLLEGE OF ENGINEERING, KADAPA
199Y1A0311@ksrmce.ac.in	GANUGAPENTA BHARATH	II/III	MECH	199Y1A0311	K.S.R.M. COLLEGE OF ENGINEERING, KADAPA
199Y1A0312@ksrmce.ac.in	GODDENDLA ASHOK KUMAR	II/III	MECH	199Y1A0312	K.S.R.M. COLLEGE OF ENGINEERING, KADAPA
199Y1A0313@ksrmce.ac.in	GUDURU SUBHAN	II/III	MECH	199Y1A0313	K.S.R.M. COLLEGE OF ENGINEERING, KADAPA
199Y1A0315@ksrmce.ac.in	KAPURAM VAMSHINATH REDDY	II/III	MECH	199Y1A0315	K.S.R.M. COLLEGE OF ENGINEERING, KADAPA
199Y1A0316@ksrmce.ac.in	KETHIREDDY NAVEEN KUMAR REDDY	II/III	MECH	199Y1A0316	K.S.R.M. COLLEGE OF ENGINEERING, KADAPA
199Y1A0317@ksrmce.ac.in	KONANGI SUBBANNA	II/III	MECH	199Y1A0317	K.S.R.M. COLLEGE OF ENGINEERING, KADAPA
199Y1A0318@ksrmce.ac.in	KONERU SAI KARTHIK	II/III	MECH	199Y1A0318	K.S.R.M. COLLEGE OF ENGINEERING, KADAPA
199Y1A0319@ksrmce.ac.in	KOTHAPALLE VAMSIDHAR REDDY	II/III	MECH	199Y1A0319	K.S.R.M. COLLEGE OF ENGINEERING, KADAPA
199Y1A0320@ksrmce.ac.in	KUMMARI MANJUNATH	II/III	MECH	199Y1A0320	K.S.R.M. COLLEGE OF ENGINEERING, KADAPA
199Y1A0321@ksrmce.ac.in	KUMMETHA SAI KUMAR REDDY	II/III	MECH	199Y1A0321	K.S.R.M. COLLEGE OF ENGINEERING, KADAPA
199Y1A0322@ksrmce.ac.in	L M VINAY KUMAR	II/III	MECH	199Y1A0322	K.S.R.M. COLLEGE OF ENGINEERING, KADAPA
199Y1A0324@ksrmce.ac.in	MALEPATI SIVA SAI REDDY	II/III	MECH	199Y1A0324	K.S.R.M. COLLEGE OF ENGINEERING, KADAPA

199Y1A0325@ksrmce.ac.in	MANJUNATHA DINESH KUMAR	II/III	MECH	199Y1A0325	K.S.R.M. COLLEGE OF ENGINEERING, KADAPA
199Y1A0326@ksrmce.ac.in	MARKAPURAM MYSORA REDDY	II/III	MECH	199Y1A0326	K.S.R.M. COLLEGE OF ENGINEERING, KADAPA
199Y1A0327@ksrmce.ac.in	MEDIMALA KIRAN KUMAR	II/III	MECH	199Y1A0327	K.S.R.M. COLLEGE OF ENGINEERING, KADAPA
199Y1A0328@ksrmce.ac.in	MOGHAL JUNAID BAIG	II/III	MECH	199Y1A0328	K.S.R.M. COLLEGE OF ENGINEERING, KADAPA
199Y1A0329@ksrmce.ac.in	MOLAKALA SREEKANTH REDDY	II/III	MECH	199Y1A0329	K.S.R.M. COLLEGE OF ENGINEERING, 31DAPA
199Y1A0330@ksrmce.ac.in	MOYILLA CHARAN REDDY	II/III	MECH	199Y1A0330	KS.R.M. COLLEGE OF ENGINEERING, KADAPA
199Y1A0331@ksrmce.ac.in	NADIMINTI NAVANEETH KUMAR	II/III	MECH	199Y1A0331	K.S.R.M. COLLEGE OF ENGINEERING, KADAPA
199Y1A0332@ksrmce.ac.in	NAGULAGARI VENKATA SANDEEP KUMAR REDDY	II/III	MECH	199Y1A0332	K.S.R.M. COLLEGE OF ENGINEERING, KADAPA
199Y1A0333@ksrmce.ac.in	PAGIDIPALEM VAMSI ACHARI	II/III	MECH	199Y1A0333	K.S.R.M. COLLEGE OF ENGINEERING, KADAPA
199Y1A0334@ksrmce.ac.in	PALLETI VAMSIDHAR REDDY	II/III	MECH	199Y1A0334	K.S.R.M. COLLEGE OF ENGINEERING, KADAPA
199Y1A0335@ksrmce.ac.in	PASUPALA RAVI KUMAR	II/III	MECH	199Y1A0335	K.S.R.M. COLLEGE OF ENGINEERING, KADAPA
199Y1A0336@ksrmce.ac.in	PATHAN KHALEELULLA KHAN	II/III	MECH	199Y1A0336	K.S.R.M. COLLEGE OF ENGINEERING, KADAPA
199Y1A0337@ksrmce.ac.in	PULAKONDAM BHEEMAIAH	II/III	MECH	199Y1A0337	K.S.R.M. COLLEGE OF ENGINEERING, KADAPA
199Y1A0338@ksrmce.ac.in	REDDAM VEERA TEJASWAR REDDY	II/III	MECH	199Y1A0338	K.S.R.M. COLLEGE OF ENGINEERING, KADAPA
199Y1A0339@ksrmce.ac.in	S K RAJESH	II/III	MECH	199Y1A0339	K.S.R.M. COLLEGE OF ENGINEERING, KADAPA
199Y1A0340@ksrmce.ac.in	SAGIRAJU DILLI VARMA	II/III	MECH	199Y1A0340	K.S.R.M. COLLEGE OF ENGINEERING, KADAPA
199Y1A0341@ksrmce.ac.in	SHAIK ABDUL RASHEED	II/III	MECH	199Y1A0341	K.S.R.M. COLLEGE OF ENGINEERING, KADAPA
199Y1A0343@ksrmce.ac.in	SHAIK GHOUSE BASHA	II/III	MECH	199Y1A0343	K.S.R.M. COLLEGE OF ENGINEERING, KADAPA
199Y1A0344@ksrmce.ac.in	SHAIK KURNOOL DADA KHALANDAR	II/III	MECH	199Y1A0344	K.S.R.M. COLLEGE OF ENGINEERING, KADAPA
199Y1A0345@ksrmce.ac.in	SHAIK MAHAMMED MANSOOR	II/III	MECH	199Y1A0345	K.S.R.M. COLLEGE OF ENGINEERING, KADAPA
199Y1A0346@ksrmce.ac.in	SHAIK MAHAMMED GHOUSE	II/III	MECH	199Y1A0346	K.S.R.M. COLLEGE OF ENGINEERING, KADAPA
199Y1A0347@ksrmce.ac.in	SHAIK MAHAMMED SAJID	II/III	MECH	199Y1A0347	K.S.R.M. COLLEGE OF ENGINEERING, KADAPA
199Y1A0348@ksrmce.ac.in	SHAIK MAHAMMED SHOAB AKTHAR	II/III	MECH	199Y1A0348	K.S.R.M. COLLEGE OF ENGINEERING, KADAPA
199Y1A0349@ksrmce.ac.in	SHAIK NAYEEMUR RAHMAN	II/III	MECH	199Y1A0349	K.S.R.M. COLLEGE OF ENGINEERING, KADAPA
199Y1A0350@ksrmce.ac.in	SHAIK ZABEEULLA	II/III	MECH	199Y1A0350	K.S.R.M. COLLEGE OF ENGINEERING, KADAPA
199Y1A0352@ksrmce.ac.in	SUDA ABHILASH KUMAR REDDY	II/III	MECH	199Y1A0352	K.S.R.M. COLLEGE OF ENGINEERING, KADAPA
199Y1A0353@ksrmce.ac.in	SUNKESULA BABA SAB	II/III	MECH	199Y1A0353	K.S.R.M. COLLEGE OF ENGINEERING, KADAPA
199Y1A0354@ksrmce.ac.in	SYED ASLAM	II/III	MECH	199Y1A0354	K.S.R.M. COLLEGE OF ENGINEERING, KADAPA
199Y1A0355@ksrmce.ac.in	TAMMINENI SURENDRA NAIDU	II/III	MECH	199Y1A0355	K.S.R.M. COLLEGE OF ENGINEERING, KADAPA
199Y1A0356@ksrmce.ac.in	VANGALA BHARGAVA KUMAR REDDY	II/III	MECH	199Y1A0356	K.S.R.M. COLLEGE OF ENGINEERING, KADAPA
199Y1A0357@ksrmce.ac.in	VENKATAGIRI BHARGAV	II/III	MECH	199Y1A0357	K.S.R.M. COLLEGE OF ENGINEERING, KADAPA
199Y1A0358@ksrmce.ac.in	VUTUKURU HITESH REDDY	II/III	MECH	199Y1A0358	K.S.R.M. COLLEGE OF ENGINEERING, KADAPA
199Y1A0359@ksrmce.ac.in	YANDAPALLI SAI KUMAR REDDY	II/III	MECH	199Y1A0359	K.S.R.M. COLLEGE OF ENGINEERING, KADAPA
199Y1A0360@ksrmce.ac.in	YERRAPUREDDY HARSHAVARDHAN REDDY	II/III	MECH	199Y1A0360	K.S.R.M. COLLEGE OF ENGINEERING, KADAPA

209Y5A0301ksrmce.ac.in	ACHUKATLA NUMAIR	II/III	MECH	209Y5A0301	K.S.R.M. COLLEGE OF ENGINEERING, KADAPA
209Y5A0302@ksrmce.ac.in	BHOJANAPALLE NAGA SIVA	II/III	MECH	209Y5A0302	K.S.R.M. COLLEGE OF ENGINEERING, KADAPA
209Y5A0303@ksrmce.ac.in	BIJJE PURUSHOTHAM	II/III	MECH	209Y5A0303	K.S.R.M. COLLEGE OF ENGINEERING, KADAPA
209Y5A0304@ksrmce.ac.in	BUCHUPALLI SIVA PRASAD REDDY	II/III	MECH	209Y5A0304	K.S.R.M. COLLEGE OF ENGINEERING, KADAPA
209Y5A0305@ksrmce.ac.in	CHINNI GURU PRASAD	II/III	MECH	209Y5A0305	K.S.R.M. COLLEGE OF ENGINEERING, KADAPA
209Y5A0306ksrmce.ac.in	CHINTHAGINJALA VENKATA SUBBARAYUDU	II/III	MECH	209Y5A0306	K.S.R.M. COLLEGE OF ENGINEERING, KADAPA
209Y5A0307@ksrmce.ac.in	CHITRALA VENKATA SWAMY SETTY	II/III	MECH	209Y5A0307	K.S.R.M. COLLEGE OF ENGINEERING, KADAPA
209Y5A0308@ksrmce.ac.in	DAKALA SRINIVASULU	II/III	MECH	209Y5A0308	K.S.R.M. COLLEGE OF ENGINEERING, KADAPA
209Y5A0309@ksrmce.ac.in	DHARA SUNIL KUMAR	II/III	MECH	209Y5A0309	K.S.R.M. COLLEGE OF ENGINEERING, KADAPA
209Y5A0310@ksrmce.ac.in	ESLAVATH RAVI NAIK	II/III	MECH	209Y5A0310	K.S.R.M. COLLEGE OF ENGINEERING, KADAPA
209Y5A0311@ksrmce.ac.in	GORLA CHARAN KUMAR REDDY	II/III	MECH	209Y5A0311	K.S.R.M. COLLEGE OF ENGINEERING, KADAPA
209Y5A0312@ksrmce.ac.in	GUDISHA DILIP KUMAR	II/III	MECH	209Y5A0312	K.S.R.M. COLLEGE OF ENGINEERING, 14DAPA
209Y5A0313@ksrmce.ac.in	GUTTURU GIRISHKUMAR REDDY	II/III	MECH	209Y5A0313	K.S.R.M. COLLEGE OF ENGINEERING, KADAPA
209Y5A0314ksrmce.ac.in	JAMPANGI OBULESU	II/III	MECH	209Y5A0314	K.S.R.M. COLLEGE OF ENGINEERING, KADAPA
209Y5A0315ksrmce.ac.in	JONNADULA SATISH	II/III	MECH	209Y5A0315	K.S.R.M. COLLEGE OF ENGINEERING, KADAPA
209Y5A0316@ksrmce.ac.in	KOTA UPENDRA REDDY	II/III	MECH	209Y5A0316	K.S.R.M. COLLEGE OF ENGINEERING, KADAPA
209Y5A0317@ksrmce.ac.in	KUNU SIVA BABJI	II/III	MECH	209Y5A0317	K.S.R.M. COLLEGE OF ENGINEERING, KADAPA
209Y5A0318@ksrmce.ac.in	KURUVA AJAY KUMAR	II/III	MECH	209Y5A0318	K.S.R.M. COLLEGE OF ENGINEERING, KADAPA
209Y5A0319@ksrmce.ac.in	LAKKINENI SUDHARSHAN	II/III	MECH	209Y5A0319	K.S.R.M. COLLEGE OF ENGINEERING, KADAPA
209Y5A0320@ksrmce.ac.in	LANKAMSETTY VENKATA LOKESH	II/III	MECH	209Y5A0320	K.S.R.M. COLLEGE OF ENGINEERING, KADAPA
209Y5A0321@ksrmce.ac.in	LINGAMBOTI BHUSHAN	II/III	MECH	209Y5A0321	K.S.R.M. COLLEGE OF ENGINEERING, KADAPA
209Y5A0322@ksrmce.ac.in	MEALLA GOWTHAM SAI	II/III	MECH	209Y5A0322	K.S.R.M. COLLEGE OF ENGINEERING, KADAPA
209Y5A0323@ksrmce.ac.in	MEDIREDDY BHARATH REDDY	II/III	MECH	209Y5A0323	K.S.R.M. COLLEGE OF ENGINEERING, KADAPA
209Y5A0324@ksrmce.ac.in	MOKA VEERABHADRA	II/III	MECH	209Y5A0324	K.S.R.M. COLLEGE OF ENGINEERING, KADAPA
209Y5A0325@ksrmce.ac.in	MOOLI CHENNAKESAVA REDDY	II/III	MECH	209Y5A0325	K.S.R.M. COLLEGE OF ENGINEERING, KADAPA
209Y5A0326@ksrmce.ac.in	NEELAM PAVAN KUMAR	II/III	MECH	209Y5A0326	K.S.R.M. COLLEGE OF ENGINEERING, KADAPA
209Y5A0327@ksrmce.ac.in	PATTU MONESH	II/III	MECH	209Y5A0327	K.S.R.M. COLLEGE OF ENGINEERING, KADAPA
209Y5A0328@ksrmce.ac.in	PATURU NARASIMHA REDDY	II/III	MECH	209Y5A0328	K.S.R.M. COLLEGE OF ENGINEERING, KADAPA
209Y5A0329@ksrmce.ac.in	PETNIKOTA ADINARAYANA	II/III	MECH	209Y5A0329	K.S.R.M. COLLEGE OF ENGINEERING, KADAPA
209Y5A0330@ksrmce.ac.in	PINNAPURAM MADHU SUDHAN	II/III	MECH	209Y5A0330	K.S.R.M. COLLEGE OF ENGINEERING, KADAPA
209Y5A0331@ksrmce.ac.in	POREDDY HARI VARDHAN REDDY	II/III	MECH	209Y5A0331	K.S.R.M. COLLEGE OF ENGINEERING, KADAPA
209Y5A0332@ksrmce.ac.in	PRODDATURU NAZEER BASHA	II/III	MECH	209Y5A0332	K.S.R.M. COLLEGE OF ENGINEERING, KADAPA
209Y5A0333@ksrmce.ac.in	SALIPELA VENKATA SUDHEER REDDY	II/III	MECH	209Y5A0333	K.S.R.M. COLLEGE OF ENGINEERING, KADAPA
209Y5A0334@ksrmce.ac.in	SAYYED MAHAMMED ALI	II/III	MECH	209Y5A0334	K.S.R.M. COLLEGE OF ENGINEERING, KADAPA
209Y5A0335@ksrmce.ac.in	SETTY TARUN KUMAR	II/III	MECH	209Y5A0335	K.S.R.M. COLLEGE OF ENGINEERING, KADAPA
209Y5A0336@ksrmce.ac.in	SHAIK MAZ AHAMED	II/III	MECH	209Y5A0336	K.S.R.M. COLLEGE OF ENGINEERING, KADAPA

209Y5A0337@ksrmce.ac.in	SUNKARI UDAY KIRAN	II/III	MECH	209Y5A0337	K.S.R.M. COLLEGE OF ENGINEERING, KADAPA
209Y5A0338@ksrmce.ac.in	SYED FAROOQ	II/III	MECH	209Y5A0338	K.S.R.M. COLLEGE OF ENGINEERING, KADAPA
209Y5A0339@ksrmce.ac.in	SYED SAMI UDDIN	II/III	MECH	209Y5A0339	K.S.R.M. COLLEGE OF ENGINEERING, KADAPA
209Y5A0340@ksrmce.ac.in	TELUGU LAKSHMANNA	II/III	MECH	209Y5A0340	K.S.R.M. COLLEGE OF ENGINEERING, KADAPA
209Y5A0341@ksrmce.ac.in	THOTA SATHISHREDDY	II/III	MECH	209Y5A0341	K.S.R.M. COLLEGE OF ENGINEERING, KADAPA
209Y5A0342@ksrmce.ac.in	VADDE SRAVAN KUMAR	II/III	MECH	209Y5A0342	K.S.R.M. COLLEGE OF ENGINEERING, KADAPA
209Y5A0343@ksrmce.ac.in	YATAGIRI HEMANTH KUMAR	II/III	MECH	209Y5A0343	K.S.R.M. COLLEGE OF ENGINEERING, KADAPA
209Y5A0344@ksrmce.ac.in	YEDDULADODDI ASHOK	II/III	MECH	209Y5A0344	K.S.R.M. COLLEGE OF ENGINEERING, KADAPA
209Y5A0345@ksrmce.ac.in	YEDUGURU SHASHI KIRAN REDDY	II/III	MECH	209Y5A0345	K.S.R.M. COLLEGE OF ENGINEERING, KADAPA
209Y5A0346@ksrmce.ac.in	YERRABALLI VENU	II/III	MECH	209Y5A0346	K.S.R.M. COLLEGE OF ENGINEERING, KADAPA

Coordinator

HOD

**Professor & head
Department of Mechanical Engineering
K.S.R.M. College of Engineering
KADAPA - 516 003.**



K.S.R.M. COLLEGE OF ENGINEERING
(UGC-AUTONOMOUS)

Kadapa, Andhra Pradesh, India- 516 003

Approved by AICTE, New Delhi & Affiliated to JNTUA, Ananthapuramu.

An ISO 14001:2004 & 9001: 2015 Certified Institution



KSNR
lives on...

Date: 14-12-2020

Name of the Event : Guest Lecture on ;Awareness for Mechanical Students'

Venue : Off line Mode in Mechanical Seminar Hall

List of Participants

SNO	Name	Department	Email Id	Signature
1	GUNTHA MANI SAGAR	MECHANICAL	199Y5A0311@ksrmce.ac.in	C. Mani Sagar
2	MAKAM JOSHUA	MECHANICAL	199Y5A0323@ksrmce.ac.in	M. Joshua
3	AKULA SREEDHAR	MECHANICAL	199Y1A0301@ksrmce.ac.in	A. Sreedhar
4	B SRINIDHI SAI	MECHANICAL	199Y1A0302@ksrmce.ac.in	B. Srinidhi Sai
5	BANDI SHIVA REDDY	MECHANICAL	199Y1A0303@ksrmce.ac.in	B. Shiva Reddy
6	CHAGANTI SUNIL KUMAR REDDY	MECHANICAL	199Y1A0304@ksrmce.ac.in	C. Sunil Kumar Reddy
7	CHEPPALI AMATHYA	MECHANICAL	199Y1A0305@ksrmce.ac.in	C. Amathya
8	CHIRUCHAPALA ABDUL SUBAHAN	MECHANICAL	199Y1A0306@ksrmce.ac.in	C. Abdul Subhan
9	DEVAPATLA BHARATH SIMHA	MECHANICAL	199Y1A0307@ksrmce.ac.in	D. Bharath Simha



/ksrmce.ac.in

Follow Us:



/ksrmceofficial

	REDDY			
10	DUDIMANI SAI SRUJAN KUMAR	MECHANICAL	199Y1A0308@ksrmce.ac.in	D. Sai Srujan Kumar
11	GADIKOTA MURALIDHAR REDDY	MECHANICAL	199Y1A0309@ksrmce.ac.in	G. MURALIDHAR
12	GANGALA VENKATA PRATHAP	MECHANICAL	199Y1A0310@ksrmce.ac.in	G. Prathap
13	GANUGAPENTA BHARATH	MECHANICAL	199Y1A0311@ksrmce.ac.in	G. Bharath
14	GODDENDLA ASHOK KUMAR	MECHANICAL	199Y1A0312@ksrmce.ac.in	G. Ashok
15	GUDURU SUBHAN	MECHANICAL	199Y1A0313@ksrmce.ac.in	G. Subhan
16	KAPURAM VAMSHINATH REDDY	MECHANICAL	199Y1A0315@ksrmce.ac.in	K. Vamsi
17	KETHIREDDY NAVEEN KUMAR REDDY	MECHANICAL	199Y1A0316@ksrmce.ac.in	K. Naveen Kumar Reddy
18	KONANGI SUBBANNA	MECHANICAL	199Y1A0317@ksrmce.ac.in	K. Subbanna
19	KONERU SAI KARTHIK	MECHANICAL	199Y1A0318@ksrmce.ac.in	K. Saikarthik
20	KOTHAPALLE VAMSIDHAR REDDY	MECHANICAL	199Y1A0319@ksrmce.ac.in	K. Vamsidhar
21	KUMMARI MANJUNATH	MECHANICAL	199Y1A0320@ksrmce.ac.in	K. Sai Kumar
22	KUMMETHA SAI KUMAR REDDY	MECHANICAL	199Y1A0321@ksrmce.ac.in	K. Sai Kumar Reddy
23	L M VINAY KUMAR	MECHANICAL	199Y1A0322@ksrmce.ac.in	L. Vinay
24	MALEPATI SIVA SAI REDDY	MECHANICAL	199Y1A0324@ksrmce.ac.in	M. Sai Reddy
25	MANJUNATHA DINESH KUMAR	MECHANICAL	199Y1A0325@ksrmce.ac.in	M. Dinesh Kumar
26	MARKAPURAM MYSORA REDDY	MECHANICAL	199Y1A0326@ksrmce.ac.in	M. Mysora Reddy
27	MEDIMALA KIRAN KUMAR	MECHANICAL	199Y1A0327@ksrmce.ac.in	M. Kiran Kumar
28	MOGHAL JUNAID BAIG	MECHANICAL	199Y1A0328@ksrmce.ac.in	M. Junaid Baig
29	MOLAKALA SREEKANTH REDDY	MECHANICAL	199Y1A0329@ksrmce.ac.in	M. Sreekanth
30	MOYILLA CHARAN REDDY	MECHANICAL	199Y1A0330@ksrmce.ac.in	M. Charan
31	NADIMINTI NAVANEETH KUMAR	MECHANICAL	199Y1A0331@ksrmce.ac.in	N. Navaneeth Kumar
32	NAGULAGARI VENKATA SANDEEP KUMAR REDDY	MECHANICAL	199Y1A0332@ksrmce.ac.in	N. Venkata Sandeep
33	PAGIDIPALEM VAMSI ACHARI	MECHANICAL	199Y1A0333@ksrmce.ac.in	P. Vamsidhar Reddy
34	PALLETI VAMSIDHAR REDDY	MECHANICAL	199Y1A0334@ksrmce.ac.in	P. Ravi
35	PASUPALA RAVI KUMAR	MECHANICAL	199Y1A0335@ksrmce.ac.in	P. Ravi
36	PATHAN KHALEELULLA KHAN	MECHANICAL	199Y1A0336@ksrmce.ac.in	P. Khaleelulla Khan
37	PULAKONDAM BHEEMAIHAH	MECHANICAL	199Y1A0337@ksrmce.ac.in	P. Bheemiah



/ksrmce.ac.in

Follow Us:



/ksrmceofficial

38	REDDAM VEERA TEJASWAR REDDY	MECHANICAL	199Y1A0338@ksrmce.ac.in	Tejaswar Reddy
39	S K RAJESH	MECHANICAL	199Y1A0339@ksrmce.ac.in	Rajesh
40	SAGIRAJU DILLI VARMA	MECHANICAL	199Y1A0340@ksrmce.ac.in	Dilli Varma
41	SHAIK ABDUL RASHEED	MECHANICAL	199Y1A0341@ksrmce.ac.in	S. Rasheed
42	SHAIK GHOUSE BASHA	MECHANICAL	199Y1A0343@ksrmce.ac.in	S. Ghouse Basha
43	SHAIK KURNOOL DADA KHALANDAR	MECHANICAL	199Y1A0344@ksrmce.ac.in	Khalandar
44	SHAIK MAHAMMED MANSOOR	MECHANICAL	199Y1A0345@ksrmce.ac.in	Mansoor
45	SHAIK MAHAMMED GHOUSE	MECHANICAL	199Y1A0346@ksrmce.ac.in	Ghouse
46	SHAIK MAHAMMED SAJID	MECHANICAL	199Y1A0347@ksrmce.ac.in	Sajid
47	SHAIK MAHAMMED SHOAB AKTHAR	MECHANICAL	199Y1A0348@ksrmce.ac.in	SHOAB AKTHAR
48	SHAIK NAYEEMUR RAHMAN	MECHANICAL	199Y1A0349@ksrmce.ac.in	RAHMAN
49	SHAIK ZABEEULLA	MECHANICAL	199Y1A0350@ksrmce.ac.in	ZABEEULLA
50	SUDA ABHILASH KUMAR REDDY	MECHANICAL	199Y1A0352@ksrmce.ac.in	ZABEEULLA ABHILASH
51	SUNKESULA BABA SAB	MECHANICAL	199Y1A0353@ksrmce.ac.in	Baba Sab
52	SYED ASLAM	MECHANICAL	199Y1A0354@ksrmce.ac.in	S. Aslam
53	TAMMINENI SURENDRA NAIDU	MECHANICAL	199Y1A0355@ksrmce.ac.in	T. Surendra
54	VANGALA BHARGAVA KUMAR REDDY	MECHANICAL	199Y1A0356@ksrmce.ac.in	V. Bhargava Reddy
55	VENKATAGIRI BHARGAV	MECHANICAL	199Y1A0357@ksrmce.ac.in	V. Bhargav
56	VUTUKURU HITESH REDDY	MECHANICAL	199Y1A0358@ksrmce.ac.in	V. Hitesh Reddy
57	YANDAPALLI SAI KUMAR REDDY	MECHANICAL	199Y1A0359@ksrmce.ac.in	Sai Kumar
58	YERRAPUREDDY HARSHAVARDHAN REDDY	MECHANICAL	199Y1A0360@ksrmce.ac.in	Y. Reddy
59	ACHUKATLA NUMAIR	MECHANICAL	209Y5A0301@ksrmce.ac.in	A. Numair
60	BHOJANAPALLE NAGA SIVA	MECHANICAL	209Y5A0302@ksrmce.ac.in	B. Nagasiva
61	BIJE PURUSHOTHAM	MECHANICAL	209Y5A0303@ksrmce.ac.in	B. Purushotham
62	BUCHUPALLI SIVA PRASAD REDDY	MECHANICAL	209Y5A0304@ksrmce.ac.in	Siva Reddy
63	CHINNI GURU PRASAD	MECHANICAL	209Y5A0305@ksrmce.ac.in	C. Guru Prasad
64	CHINTHAGINJALA VENKATA SUBBARAYUDU	MECHANICAL	209Y5A0306@ksrmce.ac.in	Subbarayudu



65	CHITRALA VENKATA SWAMY SETTY	MECHANICAL	209Y5A0307@ksrmce.ac.in	C. Venkata Swamy Setty
66	DAKALA SRINIVASULU	MECHANICAL	209Y5A0308@ksrmce.ac.in	D. Srinivasulu
67	DHARA SUNIL KUMAR	MECHANICAL	209Y5A0309@ksrmce.ac.in	D. Sunil Kumar
68	ESLAVATH RAVI NAIK	MECHANICAL	209Y5A0310@ksrmce.ac.in	E. Ravi Naik
69	GORLA CHARAN KUMAR REDDY	MECHANICAL	209Y5A0311@ksrmce.ac.in	Charan Reddy
70	GUDISHA DILIP KUMAR	MECHANICAL	209Y5A0312@ksrmce.ac.in	G. Dilip Kumar
71	GUTTURU GIRISHKUMAR REDDY	MECHANICAL	209Y5A0313@ksrmce.ac.in	G. Girish Kumar Reddy
72	JAMPANGI OBULESU	MECHANICAL	209Y5A0314@ksrmce.ac.in	J. Obulesu
73	JONNADULA SATISH	MECHANICAL	209Y5A0315@ksrmce.ac.in	J. Satish
74	KOTA UPENDRA REDDY	MECHANICAL	209Y5A0316@ksrmce.ac.in	K. Upendra Reddy
75	KUNU SIVA BABJI	MECHANICAL	209Y5A0317@ksrmce.ac.in	K. Siva Babji
76	KURUVA AJAY KUMAR	MECHANICAL	209Y5A0318@ksrmce.ac.in	Ajay
77	LAKKINENI SUDHARSHAN	MECHANICAL	209Y5A0319@ksrmce.ac.in	L. Sudharshan
78	LANKAMSETTY VENKATA LOKESH	MECHANICAL	209Y5A0320@ksrmce.ac.in	L.V. Lokesh
79	LINGAMBOTI BHUSHAN	MECHANICAL	209Y5A0321@ksrmce.ac.in	L. Bhushan
80	MEALLA GOWTHAM SAI	MECHANICAL	209Y5A0322@ksrmce.ac.in	Gowtham Sai
81	MEDIREDDY BHARATH REDDY	MECHANICAL	209Y5A0323@ksrmce.ac.in	M. Bharath Reddy
82	MOKA VEERABHADRA	MECHANICAL	209Y5A0324@ksrmce.ac.in	M. Veerabhadra
83	MOOLI CHENNAKESAVA REDDY	MECHANICAL	209Y5A0325@ksrmce.ac.in	M. Chennakesava Reddy
84	NEELAM PAVAN KUMAR	MECHANICAL	209Y5A0326@ksrmce.ac.in	N. Pavan Kumar
85	PATTU MONESH	MECHANICAL	209Y5A0327@ksrmce.ac.in	P. Monesh
86	PATURU NARASIMHA REDDY	MECHANICAL	209Y5A0328@ksrmce.ac.in	P. Narasimha Reddy
87	PETNIKOTA ADINARAYANA	MECHANICAL	209Y5A0329@ksrmce.ac.in	P. Adinarayana
88	PINNAPURAM MADHU SUDHAN	MECHANICAL	209Y5A0330@ksrmce.ac.in	P. Madhu Sudhan
89	POREDDY HARI VARDHAN REDDY	MECHANICAL	209Y5A0331@ksrmce.ac.in	P. Hari Vardhan Reddy
90	PRODDATURU NAZEER BASHA	MECHANICAL	209Y5A0332@ksrmce.ac.in	P. Nazeeq Basha
91	SALIPELA VENKATA SUDHEER REDDY	MECHANICAL	209Y5A0333@ksrmce.ac.in	S. Sudheer Reddy
92	SAYYED MAHAMMED ALI	MECHANICAL	209Y5A0334@ksrmce.ac.in	S. Mahammad Ali
93	SETTY TARUN KUMAR	MECHANICAL	209Y5A0335@ksrmce.ac.in	S. Tarun Kumar
94	SHAIK MAZ AHAMED	MECHANICAL	209Y5A0336@ksrmce.ac.in	S. Maz Ahamed



/ksrmce.ac.in

Follow Us:



/ksrmceofficial

95	SUNKARI UDAY KIRAN	MECHANICAL	209Y5A0337@ksrmce.ac.in	S. Uday Kiran
96	SYED FAROOQ	MECHANICAL	209Y5A0338@ksrmce.ac.in	S. Farooq
97	SYED SAMI UDDIN	MECHANICAL	209Y5A0339@ksrmce.ac.in	S. Samiuddin
98	TELUGU LAKSHMANNA	MECHANICAL	209Y5A0340@ksrmce.ac.in	T. Lakshmanna
99	THOTA SATHISHREDDY	MECHANICAL	209Y5A0341@ksrmce.ac.in	T. Sathish Reddy
100	VADDE SRAVAN KUMAR	MECHANICAL	209Y5A0342@ksrmce.ac.in	V. Sravan Kumar
101	YATAGIRI HEMANTH KUMAR	MECHANICAL	209Y5A0343@ksrmce.ac.in	Y. Hemant Kumar
102	YEDDULADODDI ASHOK	MECHANICAL	209Y5A0344@ksrmce.ac.in	Y. Ashok
103	YEDUGURU SHASHI KIRAN REDDY	MECHANICAL	209Y5A0345@ksrmce.ac.in	Y. Shashi
104	YERRABALLI VENU	MECHANICAL	209Y5A0346@ksrmce.ac.in	Y. Venu

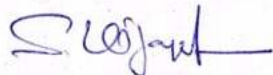
Co-Ordinator

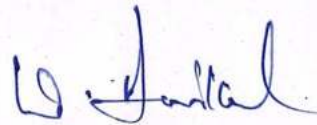
HOD
Professor & Head
Department of Mechanical Engineering
K.S.R.M. College of Engineering
KADAPA - 516 003.

Principal
PRINCIPAL
K.S.R.M. COLLEGE OF ENGINEERING
KADAPA - 516 003. (A.P.)

Feedback form On Virtual Guest Lecturer on 'Awareness for Mechanical Students'

From Dept. of Mechanical Engineering Dept, K.S.R.M.C.E

* Required

1. Email *

2. Name of the participant *

3. Designation *

4. Name of the College/Institution *

5. Is the seminar met your expectations *

Check all that apply.

- Strongly disagree
- Disagree
- Agree
- Strongly Agree

6. How would you rate the content of Guest Lecture *

Check all that apply.

- Poor
- OK
- Good
- Excellent

7. Is speaker lecture clear and understanding *

Check all that apply.

- Yes
- No

8. Suggestions if any

This content is neither created nor endorsed by Google.

Forms

Google

K.S.R.M College of Engineering (Autonomous), Kadapa
Department of Mechanical Engineering
Feedback form on
Guest Lecture on
'Awareness for Mechanical Students'

Mail ID	Name of the Student	Name of the College/Institution	Is the Guest Lecture Met your Expectation	How would you Rate the content of Guest Lecture	IS Speaker Lecture Clear and Understanding
199Y5A0311@ksrmce.ac.in	GUNTHA MANI SAGAR	K.S.R.M College of engineering	Strongly agree	Excellent	Yes
199Y5A0323@ksrmce.ac.in	MAKAM JOSHUA	K.S.R.M College of engineering	Strongly agree	Excellent	Yes
199Y1A0301@ksrmce.ac.in	AKULA SREEDHAR	K.S.R.M College of engineering	Strongly agree	Excellent	Yes
199Y1A0302@ksrmce.ac.in	B SRINIDHI SAI	K.S.R.M College of engineering	agree	Excellent	Yes
199Y1A0303@ksrmce.ac.in	BANDI SHIVA REDDY	K.S.R.M College of engineering	agree	ok	Yes
199Y1A0304@ksrmce.ac.in	CHAGANTI SUNIL KUMAR REDDY	K.S.R.M College of engineering	agree	ok	Yes
199Y1A0305@ksrmce.ac.in	CHEPPALI AMATHYA	K.S.R.M College of engineering	agree	Excellent	Yes
199Y1A0306@ksrmce.ac.in	CHIRUCHAPALA ABDUL SUBAHAN	K.S.R.M College of engineering	Strongly agree	Excellent	Yes
199Y1A0307@ksrmce.ac.in	DEVAPATLA BHARATH SIMHA REDDY	K.S.R.M College of engineering	Strongly agree	Excellent	Yes
199Y1A0308@ksrmce.ac.in	DUDIMANI SAI SRUJAN KUMAR	K.S.R.M College of engineering	Strongly agree	ok	Yes
199Y1A0309@ksrmce.ac.in	GADIKOTA MURALIDHAR REDDY	K.S.R.M College of engineering	agree	ok	Yes
199Y1A0310@ksrmce.ac.in	GANGALA VENKATA PRATHAP	K.S.R.M College of engineering	agree	Good	Yes
199Y1A0311@ksrmce.ac.in	GANUGAPENTA BHARATH	K.S.R.M College of engineering	agree	Good	Yes
199Y1A0312@ksrmce.ac.in	GODDENDLA ASHOK KUMAR	K.S.R.M College of engineering	agree	Excellent	Yes
199Y1A0313@ksrmce.ac.in	GUDURU SUBHAN	K.S.R.M College of engineering	Strongly agree	Excellent	Yes
199Y1A0315@ksrmce.ac.in	KAPURAM VAMSHINATH REDDY	K.S.R.M College of engineering	Strongly agree	Excellent	Yes
199Y1A0316@ksrmce.ac.in	KETHIREDDY NAVEEN KUMAR REDDY	K.S.R.M College of engineering	Strongly agree	Good	Yes
199Y1A0317@ksrmce.ac.in	KONANGI SUBBANNA	K.S.R.M College of engineering	agree	Good	Yes

K.S.R.M College of Engineering (Autonomous), Kadapa
Department of Mechanical Engineering
Feedback form on
Guest Lecture on
'Awareness for Mechanical Students'

199Y1A0318@ksrmce.ac.in	KONERU SAI KARTHIK	K.S.R.M College of engineering	Strongly agree	Excellent	Yes
199Y1A0319@ksrmce.ac.in	KOTHAPALLE VAMSIDHAR REDDY	K.S.R.M College of engineering	agree	Excellent	Yes
199Y1A0320@ksrmce.ac.in	KUMMARI MANJUNATH	K.S.R.M College of engineering	Strongly agree	Excellent	Yes
199Y1A0321@ksrmce.ac.in	KUMMETHA SAI KUMAR REDDY	K.S.R.M College of engineering	Strongly agree	Good	Yes
199Y1A0322@ksrmce.ac.in	L M VINAY KUMAR	K.S.R.M College of engineering	Strongly agree	Good	Yes
199Y1A0324@ksrmce.ac.in	MALEPATI SIVA SAI REDDY	K.S.R.M College of engineering	agree	Excellent	Yes
199Y1A0325@ksrmce.ac.in	MANJUNATHA DINESH KUMAR	K.S.R.M College of engineering	agree	Excellent	Yes
199Y1A0326@ksrmce.ac.in	MARKAPURAM MYSORA REDDY	K.S.R.M College of engineering	agree	Excellent	Yes
199Y1A0327@ksrmce.ac.in	MEDIMALA KIRAN KUMAR	K.S.R.M College of engineering	Strongly agree	Good	Yes
199Y1A0328@ksrmce.ac.in	MOGHAL JUNAID BAIG	K.S.R.M College of engineering	Strongly agree	Good	Yes
199Y1A0329@ksrmce.ac.in	MOLAKALA SREEKANTH REDDY	K.S.R.M College of engineering	Strongly agree	Excellent	Yes
199Y1A0330@ksrmce.ac.in	MOYILLA CHARAN REDDY	K.S.R.M College of engineering	agree	Excellent	Yes
199Y1A0331@ksrmce.ac.in	NADIMINTI NAVANEETH KUMAR	K.S.R.M College of engineering	agree	Excellent	Yes
199Y1A0332@ksrmce.ac.in	NAGULAGARI VENKATA SANDEEP KUMAR REDDY	K.S.R.M College of engineering	agree	Good	Yes
199Y1A0333@ksrmce.ac.in	PAGIDIPALEM VAMSI ACHARI	K.S.R.M College of engineering	Strongly agree	Good	Yes
199Y1A0334@ksrmce.ac.in	PALLETI VAMSIDHAR REDDY	K.S.R.M College of engineering	Strongly agree	Excellent	Yes
199Y1A0335@ksrmce.ac.in	PASUPALA RAVI KUMAR	K.S.R.M College of engineering	Strongly agree	Excellent	Yes
199Y1A0336@ksrmce.ac.in	PATHAN KHALEELULLA KHAN	K.S.R.M College of engineering	agree	Excellent	Yes
199Y1A0337@ksrmce.ac.in	PULAKONDAM BHEEMAIAH	K.S.R.M College of engineering	agree	ok	Yes
199Y1A0338@ksrmce.ac.in	REDDAM VEERA TEJASWAR REDDY	K.S.R.M College of engineering	agree	Good	Yes
199Y1A0339@ksrmce.ac.in	S K RAJESH	K.S.R.M College of engineering	Strongly agree	Good	Yes
199Y1A0340@ksrmce.ac.in	SAGIRAJU DILLI VARMA	K.S.R.M College of engineering	Strongly agree	ok	Yes

K.S.R.M College of Engineering (Autonomous), Kadapa
Department of Mechanical Engineering
Feedback form on
Guest Lecture on
'Awareness for Mechanical Students'

Mail ID	Name of the Student	Name of the College/Institution	Is the Guest Lecture Met your Expectation	How would you Rate the content of Guest Lecture	IS Speaker Lecture Clear and Understanding
199Y5A0311@ksrmce.ac.in	GUNTHA MANI SAGAR	K.S.R.M College of engineering	Strongly agree	Excellent	Yes
199Y5A0323@ksrmce.ac.in	MAKAM JOSHUA	K.S.R.M College of engineering	Strongly agree	Excellent	Yes
199Y1A0301@ksrmce.ac.in	AKULA SREEDHAR	K.S.R.M College of engineering	Strongly agree	Excellent	Yes
199Y1A0302@ksrmce.ac.in	B SRINIDHI SAI	K.S.R.M College of engineering	agree	Excellent	Yes
199Y1A0303@ksrmce.ac.in	BANDI SHIVA REDDY	K.S.R.M College of engineering	agree	ok	Yes
199Y1A0304@ksrmce.ac.in	CHAGANTI SUNIL KUMAR REDDY	K.S.R.M College of engineering	agree	ok	Yes
199Y1A0305@ksrmce.ac.in	CHEPPALI AMATHYA	K.S.R.M College of engineering	agree	Excellent	Yes
199Y1A0306@ksrmce.ac.in	CHIRUCHAPALA ABDUL SUBAHAN	K.S.R.M College of engineering	Strongly agree	Excellent	Yes
199Y1A0307@ksrmce.ac.in	DEVAPATLA BHARATH SIMHA REDDY	K.S.R.M College of engineering	Strongly agree	Excellent	Yes
199Y1A0308@ksrmce.ac.in	DUDIMANI SAI SRUJAN KUMAR	K.S.R.M College of engineering	Strongly agree	ok	Yes
199Y1A0309@ksrmce.ac.in	GADIKOTA MURALIDHAR REDDY	K.S.R.M College of engineering	agree	ok	Yes
199Y1A0310@ksrmce.ac.in	GANGALA VENKATA PRATHAP	K.S.R.M College of engineering	agree	Good	Yes
199Y1A0311@ksrmce.ac.in	GANUGAPENTA BHARATH	K.S.R.M College of engineering	agree	Good	Yes
199Y1A0312@ksrmce.ac.in	GODDENDLA ASHOK KUMAR	K.S.R.M College of engineering	agree	Excellent	Yes
199Y1A0313@ksrmce.ac.in	GUDURU SUBHAN	K.S.R.M College of engineering	Strongly agree	Excellent	Yes
199Y1A0315@ksrmce.ac.in	KAPURAM VAMSHINATH REDDY	K.S.R.M College of engineering	Strongly agree	Excellent	Yes
199Y1A0316@ksrmce.ac.in	KETHIREDDY NAVEEN KUMAR REDDY	K.S.R.M College of engineering	Strongly agree	Good	Yes
199Y1A0317@ksrmce.ac.in	KONANGI SUBBANNA	K.S.R.M College of engineering	agree	Good	Yes
199Y1A0318@ksrmce.ac.in	KONERU SAI KARTHIK	K.S.R.M College of engineering	Strongly agree	Excellent	Yes
199Y1A0319@ksrmce.ac.in	KOTHAPALLE VAMSIDHAR REDDY	K.S.R.M College of engineering	agree	Excellent	Yes

K.S.R.M College of Engineering (Autonomous), Kadapa
Department of Mechanical Engineering
Feedback form on
Guest Lecture on
'Awareness for Mechanical Students'

199Y1A0320@ksrmce.ac.in	KUMMARI MANJUNATH	K.S.R.M College of engineering	Strongly agree	Excellent	Yes
199Y1A0321@ksrmce.ac.in	KUMMETHA SAI KUMAR REDDY	K.S.R.M College of engineering	Strongly agree	Good	Yes
199Y1A0322@ksrmce.ac.in	L M VINAY KUMAR	K.S.R.M College of engineering	Strongly agree	Good	Yes
199Y1A0324@ksrmce.ac.in	MALEPATI SIVA SAI REDDY	K.S.R.M College of engineering	agree	Excellent	Yes
199Y1A0325@ksrmce.ac.in	MANJUNATHA DINESH KUMAR	K.S.R.M College of engineering	agree	Excellent	Yes
199Y1A0326@ksrmce.ac.in	MARKAPURAM MYSORA REDDY	K.S.R.M College of engineering	agree	Excellent	Yes
199Y1A0327@ksrmce.ac.in	MEDIMALA KIRAN KUMAR	K.S.R.M College of engineering	Strongly agree	Good	Yes
199Y1A0328@ksrmce.ac.in	MOGHAL JUNAID BAIG	K.S.R.M College of engineering	Strongly agree	Good	Yes
199Y1A0329@ksrmce.ac.in	MOLAKALA SREEKANTH REDDY	K.S.R.M College of engineering	Strongly agree	Excellent	Yes
199Y1A0330@ksrmce.ac.in	MOYILLA CHARAN REDDY	K.S.R.M College of engineering	agree	Excellent	Yes
199Y1A0331@ksrmce.ac.in	NADIMINTI NAVANEETH KUMAR	K.S.R.M College of engineering	agree	Excellent	Yes
199Y1A0332@ksrmce.ac.in	NAGULAGARI VENKATA SANDEEP KUMAR REDDY	K.S.R.M College of engineering	agree	Good	Yes
199Y1A0333@ksrmce.ac.in	PAGIDIPALEM VAMSI ACHARI	K.S.R.M College of engineering	Strongly agree	Good	Yes
199Y1A0334@ksrmce.ac.in	PALLETI VAMSIDHAR REDDY	K.S.R.M College of engineering	Strongly agree	Excellent	Yes
199Y1A0335@ksrmce.ac.in	PASUPALA RAVI KUMAR	K.S.R.M College of engineering	Strongly agree	Excellent	Yes
199Y1A0336@ksrmce.ac.in	PATHAN KHALEELULLA KHAN	K.S.R.M College of engineering	agree	Excellent	Yes
199Y1A0337@ksrmce.ac.in	PULAKONDAM BHEEMAI AH	K.S.R.M College of engineering	agree	ok	Yes
199Y1A0338@ksrmce.ac.in	REDDAM VEERA TEJASWAR REDDY	K.S.R.M College of engineering	agree	Good	Yes
199Y1A0339@ksrmce.ac.in	S K RAJESH	K.S.R.M College of engineering	Strongly agree	Good	Yes
199Y1A0340@ksrmce.ac.in	SAGIRAJU DILLI VARMA	K.S.R.M College of engineering	Strongly agree	ok	Yes
199Y1A0341@ksrmce.ac.in	SHAIK ABDUL RASHEED	K.S.R.M College of engineering	Strongly agree	Excellent	Yes
199Y1A0343@ksrmce.ac.in	SHAIK GHOUSE BASHA	K.S.R.M College of engineering	agree	Excellent	Yes
199Y1A0344@ksrmce.ac.in	SHAIK KURNOOL DADA KHALANDAR	K.S.R.M College of engineering	agree	Excellent	Yes
199Y1A0345@ksrmce.ac.in	SHAIK MAHAMMED MANSOOR	K.S.R.M College of engineering	agree	ok	Yes

K.S.R.M College of Engineering (Autonomous), Kadapa
Department of Mechanical Engineering
Feedback form on
Guest Lecture on
'Awareness for Mechanical Students'

199Y1A0346@ksrmce.ac.in	SHAIK MAHAMMED GHOUSE	K.S.R.M College of engineering	Strongly agree	ok	Yes
199Y1A0347@ksrmce.ac.in	SHAIK MAHAMMED SAJID	K.S.R.M College of engineering	Strongly agree	Good	Yes
199Y1A0348@ksrmce.ac.in	SHAIK MAHAMMED SHOAB AKTHAR	K.S.R.M College of engineering	Strongly agree	Good	Yes
199Y1A0349@ksrmce.ac.in	SHAIK NAYEEMUR RAHMAN	K.S.R.M College of engineering	agree	Excellent	Yes
199Y1A0350@ksrmce.ac.in	SHAIK ZABEEULLA	K.S.R.M College of engineering	agree	Excellent	Yes
199Y1A0352@ksrmce.ac.in	SUDA ABHILASH KUMAR REDDY	K.S.R.M College of engineering	Strongly agree	Excellent	Yes
199Y1A0353@ksrmce.ac.in	SUNKESULA BABA SAB	K.S.R.M College of engineering	Strongly agree	Good	Yes
199Y1A0354@ksrmce.ac.in	SYED ASLAM	K.S.R.M College of engineering		Good	Yes
199Y1A0355ksrmce.ac.in	TAMMINENI SURENDRA NAIDU	K.S.R.M College of engineering	agree	Excellent	Yes
199Y1A0356ksrmce.ac.in	VANGALA BHARGAVA KUMAR REDDY	K.S.R.M College of engineering	agree	Excellent	Yes
199Y1A0357@ksrmce.ac.in	VENKATAGIRI BHARGAV	K.S.R.M College of engineering	agree	Excellent	Yes
199Y1A0358@ksrmce.ac.in	VUTUKURU HITESH REDDY	K.S.R.M College of engineering	agree	ok	Yes
199Y1A0359@ksrmce.ac.in	YANDAPALLI SAI KUMAR REDDY	K.S.R.M College of engineering	Strongly agree	ok	Yes
199Y1A0360@ksrmce.ac.in	YERRAPUREDDY HARSHAVARDHAN REDDY	K.S.R.M College of engineering	Strongly agree	Good	Yes
209Y5A0301ksrmce.ac.in	ACHUKATLA NUMAIR	K.S.R.M College of engineering	Strongly agree	Excellent	Yes
209Y5A0302@ksrmce.ac.in	BHOJANAPALLE NAGA SIVA	K.S.R.M College of engineering	agree	Excellent	Yes
209Y5A0303@ksrmce.ac.in	BIJJE PURUSHOTHAM	K.S.R.M College of engineering	agree	Excellent	Yes
209Y5A0304@ksrmce.ac.in	BUCHUPALLI SIVA PRASAD REDDY	K.S.R.M College of engineering	agree	Good	Yes
209Y5A0305@ksrmce.ac.in	CHINNI GURU PRASAD	K.S.R.M College of engineering	agree	Good	Yes
209Y5A0306ksrmce.ac.in	CHINTHAGINJALA VENKATA SUBBARAYUDU	K.S.R.M College of engineering	agree	ok	Yes
209Y5A0307@ksrmce.ac.in	CHITRALA VENKATA SWAMY SETTY	K.S.R.M College of engineering	Strongly agree	Excellent	Yes
209Y5A0308@ksrmce.ac.in	DAKALA SRINIVASULU	K.S.R.M College of engineering	Strongly agree	Excellent	Yes
209Y5A0309@ksrmce.ac.in	DHARA SUNIL KUMAR	K.S.R.M College of engineering	Strongly agree	Excellent	Yes

K.S.R.M College of Engineering (Autonomous), Kadapa
Department of Mechanical Engineering
Feedback form on
Guest Lecture on
'Awareness for Mechanical Students'

209Y5A0310@ksrmce.ac.in	ESLAVATH RAVI NAIK	K.S.R.M College of engineering	Strongly agree	ok	Yes
209Y5A0311@ksrmce.ac.in	GORLA CHARAN KUMAR REDDY	K.S.R.M College of engineering	agree	ok	Yes
209Y5A0312@ksrmce.ac.in	GUDISHA DILIP KUMAR	K.S.R.M College of engineering	agree	ok	Yes
209Y5A0313@ksrmce.ac.in	GUTTURU GIRISHKUMAR REDDY	K.S.R.M College of engineering		Excellent	Yes
209Y5A0314ksrmce.ac.in	JAMPANGI OBULESU	K.S.R.M College of engineering	Strongly agree	Excellent	Yes
209Y5A0315ksrmce.ac.in	JONNADULA SATISH	K.S.R.M College of engineering	Strongly agree	Excellent	Yes
209Y5A0316@ksrmce.ac.in	KOTA UPENDRA REDDY	K.S.R.M College of engineering	agree	Excellent	Yes
209Y5A0317@ksrmce.ac.in	KUNU SIVA BABJI	K.S.R.M College of engineering	agree	Excellent	Yes
209Y5A0318@ksrmce.ac.in	KURUVA AJAY KUMAR	K.S.R.M College of engineering	Strongly agree	Excellent	Yes
209Y5A0319@ksrmce.ac.in	LAKKINENI SUDHARSHAN	K.S.R.M College of engineering	Strongly agree	Good	Yes
209Y5A0320@ksrmce.ac.in	LANKAMSETTY VENKATA-LOKESH	K.S.R.M College of engineering	Strongly agree	Good	Yes
209Y5A0321@ksrmce.ac.in	LINGAMBOTI BHUSHAN	K.S.R.M College of engineering	Strongly agree	Good	Yes
209Y5A0322@ksrmce.ac.in	MEALLA GOWTHAM SAI	K.S.R.M College of engineering	Strongly agree	Good	Yes
209Y5A0323@ksrmce.ac.in	MEDIREDDY BHARATH REDDY	K.S.R.M College of engineering	agree	Good	Yes
209Y5A0324@ksrmce.ac.in	MOKA VEERABHADRA	K.S.R.M College of engineering	agree	ok	Yes
209Y5A0325@ksrmce.ac.in	MOOLI CHENNAKESAVA REDDY	K.S.R.M College of engineering	Strongly agree	ok	Yes
209Y5A0326@ksrmce.ac.in	NEELAM PAVAN KUMAR	K.S.R.M College of engineering	Strongly agree	ok	Yes
209Y5A0327@ksrmce.ac.in	PATTU MONESH	K.S.R.M College of engineering	Strongly agree	Excellent	Yes
209Y5A0328@ksrmce.ac.in	PATURU NARASIMHA REDDY	K.S.R.M College of engineering	agree	Excellent	Yes
209Y5A0329@ksrmce.ac.in	PETNIKOTA ADINARAYANA	K.S.R.M College of engineering	Strongly agree	Excellent	Yes
209Y5A0330@ksrmce.ac.in	PINNAPURAM MADHU SUDHAN	K.S.R.M College of engineering	Strongly agree	Good	Yes
209Y5A0331@ksrmce.ac.in	POREDDY HARI VARDHAN REDDY	K.S.R.M College of engineering	agree	Excellent	Yes
209Y5A0332@ksrmce.ac.in	PRODDATURU NAZEER BASHA	K.S.R.M College of engineering	agree	Good	Yes
209Y5A0333@ksrmce.ac.in	SALIPELA VENKATA SUDHEER REDDY	K.S.R.M College of engineering	agree	Excellent	Yes
209Y5A0334@ksrmce.ac.in	SAYYED MAHAMMED ALI	K.S.R.M College of engineering	agree	Good	Yes

K.S.R.M College of Engineering (Autonomous), Kadapa
Department of Mechanical Engineering
Feedback form on
Guest Lecture on
'Awareness for Mechanical Students'

209Y5A0335@ksrmce.ac.in	SETTY TARUN KUMAR	K.S.R.M College of engineering	Strongly agree	Excellent	Yes
209Y5A0336@ksrmce.ac.in	SHAIK MAZ AHAMED	K.S.R.M College of engineering	Strongly agree	Good	Yes
209Y5A0337@ksrmce.ac.in	SUNKARI UDAY KIRAN	K.S.R.M College of engineering	Strongly agree	Excellent	Yes
209Y5A0338@ksrmce.ac.in	SYED FAROOQ	K.S.R.M College of engineering	Strongly agree	Excellent	Yes
209Y5A0339@ksrmce.ac.in	SYED SAMIUDDIN	K.S.R.M College of engineering	agree	Excellent	Yes
209Y5A0340@ksrmce.ac.in	TELUGU LAKSHMANNA	K.S.R.M College of engineering	agree	Excellent	Yes
209Y5A0341@ksrmce.ac.in	THOTA SATHISHREDDY	K.S.R.M College of engineering	Strongly agree	Good	Yes
209Y5A0342@ksrmce.ac.in	VADDE SRAVAN KUMAR	K.S.R.M College of engineering	Strongly agree	Good	Yes
209Y5A0343@ksrmce.ac.in	YATAGIRI HEMANTH KUMAR	K.S.R.M College of engineering	Strongly agree	Good	Yes
209Y5A0344@ksrmce.ac.in	YEDDULADODDI ASHOK	K.S.R.M College of engineering	Strongly agree	Excellent	Yes
209Y5A0345@ksrmce.ac.in	YEDUGURU SHASHI KIRAN REDDY	K.S.R.M College of engineering	agree	Good	Yes
209Y5A0346@ksrmce.ac.in	YERRABALLI VENU	K.S.R.M College of engineering	agree	Excellent	Yes

COORDINATOR

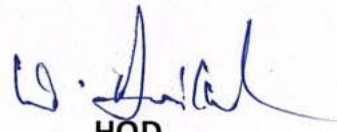
HOD
Professor & Head
Department of Mechanical Engineering
K.S.R.M. College of Engineering
KADAPA - 516 003.



K.S.R.M. COLLEGE OF ENGINEERING

(UGC-AUTONOMOUS)

Kadapa, Andhra Pradesh, India- 516 003

Approved by AICTE, New Delhi & Affiliated to JNTUA, Ananthapuramu.

An ISO 14001:2004 & 9001: 2015 Certified Institution



Lr./KSRMCE/ (Department of ME)/2020-21/

Date: 10.02.2021

To

The Principal,
K.S.R.M.College of Engineering
Kadapa.

Respected Sir,

//THROUGH PROPER CHANNEL//

Sub: KSRMCE - Department of ME-Permission and financial Assistance for A three day workshop on CATIA Requested -Reg.

It is being brought to your kind notice that, Department of Mechanical Engineering of our organization was planning to conduct A three day workshop on CATIA In association with DASSAULT SYSTEMS for faculty from 18-02-2021 to 20-02-2021.

In this regard I kindly request you to provide the permission and financial assistance to procure the needs and for smooth completion of the programme ,for which kind of act I would be grateful to you sir.

Thanking you

Yours Faithfully

Mohammed
Sri M.Mohan reddy

Suresh
Sri.J.Suresh babu

(Co-ordinators depart ment of ME)

*Forwarded to
Principal Sir*

*Permitted
V. S. S. Murthy*

Cc:

To The Director for Information
To All Deans / HoD's



K.S.R.M. COLLEGE OF ENGINEERING

(UGC- AUTONOMOUS)

Kadapa, Andhra Pradesh, India- 516 003

Approved by AICTE, New Delhi & Affiliated to JNTUA, Ananthapuramu.



Activity Report

Name of the Activity	A Three Day Workshop On Catia In Association with "DASSAULT SYSTEMS"	
Type of Activity	Workshop	
Date and Time of Activity	18-02-2021 to 20-02-2021	9 A.M TO 4 PM
No. of Participants	25 members	
Resource person	Sri.Dhaksinamurthi, Dassult Systems (Andhra pradesh)	
Coordinators	Sri.M.Mohan Reddy, Asst.Professor Sri.J.SureshBabu, Asst.Professor	
Co-Coordinator(s)	Sri. R. Mahesh, Asst. Professor	
Organizing Dept.	Mechanical Engineering	
Flat form	offline	
Venue	Engineering graphics and design lab	
Description	<p>CATIA V5, V6 and CATIA 3D EXPERIENCE are the most recent and widely used Computer-aided Design tools from Dassault Systèmes. Computer-Aided Design is most employed by Engineers to help create, modify and/or analyze graphical representations of product and designs. Its applications stretch across a multitude of industries due to its many popular benefits.</p> <p>CATIA stands for Computer Aided ThreeDimensional Interactive Application. It's much more than a CAD (Computer Aided Design) software package. It's a full software suite which incorporates CAD, CAE (Computer-Aided Engineering) and CAM (Computer-Aided Manufacture). So, let's take a look at each of these areas and the tools that CATIA offers professionals to enhance innovation in product development.</p> <p>Sri.Dhaksinamurthi, Dassult Systems (Andhra pradesh) has acted as Three Day workshop Resource Person and Presented concepts as follows</p> <p>TOPICS COVERED:</p> <p>TOOL: CATIA</p> <p>Day 01 : SKETCHER</p> <p>Introduction to Caria v5 and it's modules</p> <p>Afternoon: basic commands used in Caria v5</p> <p>Introduction to part design</p> <p>Day 02 : PART DESIGN</p> <p>advanced commands used in part design</p> <p>Practice on simple machine part drawing</p> <p>part design Of flange coupling.</p> <p>Day 03 : ASSEMBLY AND DRAFTING</p>	



/ksr

mce /ksr

official

Introduction to assembly drawing, commands used.
Practice on simple assembly, examples

In All Sessions at the End of day Interaction with participants and resources persons clarified Doubts and Final Day Workshop closed with valuable Feed back from Participants followed by Oath of Thanks to Resource persons, Participants and Management

Photos



Andhra Pradesh, India
Mechanical Engineering Block, KSRM Hostel Rd,
Andhra Pradesh 516003, India
Lat N 14° 28' 36.9588" Long E 78° 45' 58.9716"
18/02/21 11:00 AM

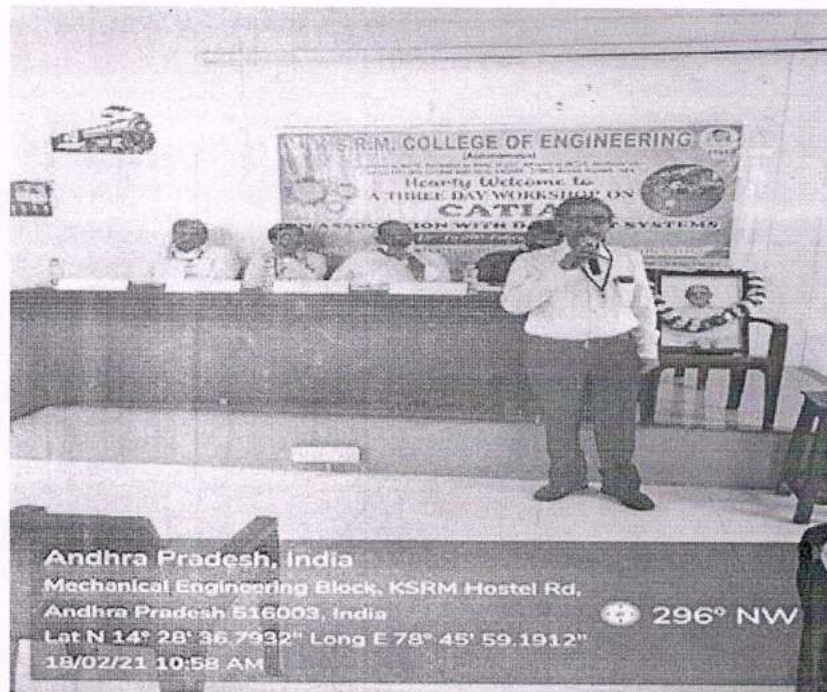

Andhra Pradesh, India
Mechanical Engineering Block, KSRM Hostel Rd,
Andhra Pradesh 516003, India
Lat N 14° 28' 36.7932" Long E 78° 45' 59.1912"
18/02/21 10:58 AM

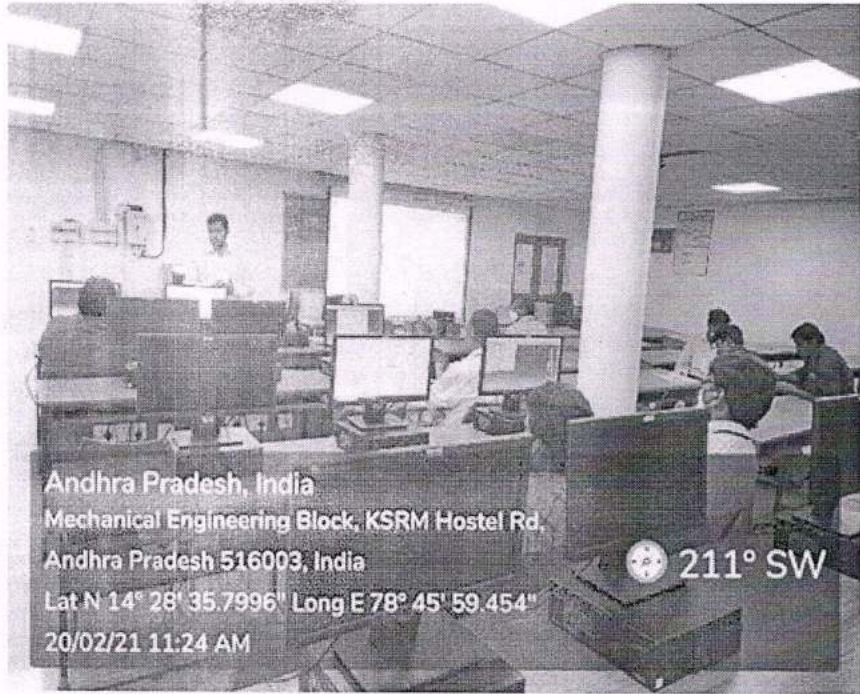

Andhra Pradesh, India
Mechanical Engineering Block, KSRM Hostel Rd,
Andhra Pradesh 516003, India
Lat N 14° 28' 35.7996" Long E 78° 45' 59.454"
20/02/21 11:24 AM

211° SW

Suresh
Coordinator

W. Jaital
HOD
Professor & head
Department of Mechanical Engineering
K.S.R.M. College of Engineering
KADAPA - 516 003.

V. S. S. Murthy
Principal
PRINCIPAL
K.S.R.M. COLLEGE OF ENGINEERING
KADAPA - 516 003. (A.P.)



K.S.R.M. COLLEGE OF ENGINEERING



KSNR
lives on.

(Autonomous)

(Approved by AICTE, Accredited by NAAC of UGC, Affiliated to JNTUA, Anathapuramu)
(An ISO 9001:2015 Certified Institution), KADAPA - 516003, Andhra Pradesh, India.

Hearty Welcome to A THREE DAY WORKSHOP ON CATIA

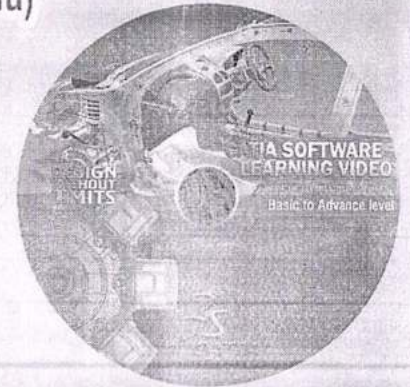

IN ASSOCIATION WITH DASSAULT SYSTEMS

18th To 20th February, 2021

“Organized by Department of Mechanical Engineering”

Coordinator M.Mohan Reddy & J.Suresh Babu	Dr. D.Ravikanth HOD, M.E.D., K.S.R.M.C.E.	Prof. V.S.S.Murthy Principal K.S.R.M.C.E.	Prof. A.Mohan Director Kandula Group of Institutions	Sri K.Chandra Obul Reddy Management Member K.S.R.M.C.E.	Sri. K.Magan Mohan Reddy Vice-Chairman K.S.R.M.C.E.	Smt. K.Rajeswari Correspondent, Secretary & Treasurer K.S.R.M.C.E.	Sri K.Raja Mohan Reddy Chairman K.S.R.M.C.E.
--	---	---	--	---	---	--	--

**A THREE DAY WORKSHOP ON
CATIA**

FEB – 18 To 20 – 2021

REGISTRATION FORM

Name :

Age :

Gender :

Qualification :

Designation :

Name of the Institution:.....

.....

Department :

Mobile No:.....

Email ID:.....

The information provided here with is true to the best of my knowledge. I agree to abide by the rules and regulations governing the workshop Program.

Date:

Signature of the applicant

Signature&Seal of the Head of the Institution

ORGANIZING COMMITTEE

CHIEF PATRON

Sri.K.Rajamohan Reddy , Chairman

Smt.K.Rajeswari ,Correspondent

Sri. K. Madan Mohan Reddy, Vice Chairman

Sri. K. Chandra Obul Reddy, (Management Member and Director of KOR Ginning and Oil Mills Pvt. Ltd.)

PATRON

Prof. A. Mohan, Director

CHAIRMAN

Dr. V. S. S. Murthy, Professor, Principal

PRESIDENT

Dr.D.Ravikanth,Professor, HOD

COORDINATORS

Sri.M.Mohan Reddy,Asst.Professor

Sri.J.SureshBabu, Asst.Professor

CO-COORDINATOR

Sri. R. Mahesh, Asst. Professor

ORGANIZING COMMITTEE

Dr. A. Saravan, Professor

Sri. K. Suresh Kumar, Assoc. Professor

Sri. R.R.K. Reddy, Assoc.Professor

Dr.B.Sudharshan, Assoc. Professor

Sri. C. Nagaraja, Assoc. Professor

Dr. P. Srinivas, Asst.Professor

Sri.A. Hari Krishna, Asst.professor

Sri.S.VijayaKumar,Asst.Professor

Sri. B. Srihari, Asst. Professor

Sri.U.Pradeep Kumar, Asst. Professor

Sri.S.Mahaboob Khan , Asst. Professor

Sri.P.K.Chaitanya Kanth Reddy, Asst. Professor

Sri.D.Merwin Rajesh, Asst. Professor

Sri.P.Siva Seshu, Asst. Professor

Dr.B.Dhrama lingam, Asst. Professor

Dr.P.Bhanu Prakash, Asst. Professor

CONTACT

Sri.J.SureshBabu, Asst.Professor, ME

KSRM College of Engineering (Autonomous)

Phone No: 9247181832

Email: Jsuresh@ksrmce.ac.in



**DEPARTMENT OF
MECHANICAL ENGINEERING**

**A THREE DAY WORKSHOP ON
CATIA**

**IN ASSOCIATION WITH
"DASSAULT SYSTEMS"**

FEB-18 To 20 – 2021

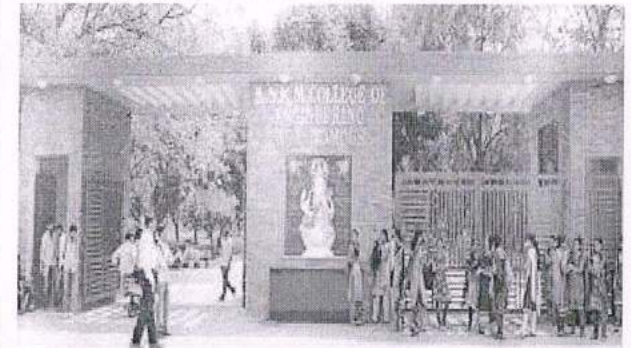

KSRM COLLEGE OF ENGINEERING

(AUTONOMOUS)

Affiliated to JNTUA

Kadapa – 516003,AP

Website : www.ksrmce.ac.in

ABOUT THE COLLEGE

Kandula Srinivasa Reddy Memorial (K.S.R.M) College of Engineering was established in the year 1980, in the memory of late Sri. Kandula Srinivasa Reddy, youngest son of Late Sri Obul Reddy, former Member of Parliament. The institute is Autonomous and approved by AICTE, Accredited by NBA, NEW DELHI, ISO 9001:2008 Certified institution, and Affiliated to Jawaharlal Nehru Technological University, Anantapuramu.

The mission and purpose in establishing KSRM college of Engineering is to impact quality of education in Engineering at under graduation and post graduation levels aiming to achieve the status of the best Engineering college and there by fulfill the dreams of the founder chairman and the aspirations of students community in the region to become world class professional and technocrats.

The institute offers B.Tech courses in CE, CSE, ECE, EEE and ME. The institute also offers postgraduate courses namely M. Tech in power systems, geotechnical engineering, computer science engineering, CAD-CAM, DECS and MBA. The institute has spacious campus of over 39000 sq.m. Built-up area and surrounded by plenty of greenery.

ABOUT THE DEPARTMENT

Department was established in the year 1980 and meets the growing demands of Industry and Society. The Department has well qualified and experienced faculty, and state of the art laboratory facilities. Alumni are well placed in India and abroad and many of them are presently pursuing their education in IISC, IIT's, NIT's and premier institutes.

THEME OF THE COURSE

CATIA V5, V6 and CATIA 3D EXPERIENCE are the most recent and widely used Computer-aided Design tools from Dassault Systèmes.

Computer-Aided Design is most employed by Engineers to help create, modify and/or analyze graphical representations of product+designs. Its applications stretch across a multitude of industries due to its many popular benefits.

CATIA stands for Computer Aided Three-Dimensional Interactive Application. It's much more than a CAD (Computer Aided Design) software package. It's a full software suite which incorporates CAD, CAE (Computer-Aided Engineering) and CAM (Computer-Aided Manufacture). So, let's take a look at each of these areas and the tools that CATIA offers professionals to enhance innovation in product development.

TOPICS TO BE COVERED:

TOOL: CATIA

Day 01 : SKETCHER

Day 02 : PART DESIGN

Day 03 : ASSEMBLY AND DRAFTING

RESOURCE PERSON:

Sri.Dhaksinamurthi,
Dassult Systems (Andhra pradesh)

REGISTRATION DETAILS

Registration Fee/Participant:

1. Faculty: Rs 1000/-

2. Industrial Professionals: RS 500/-

PAYMENT MODE: Cash only

The registration fee includes workshop kit, refreshment and working lunch. The interested participants need to fill the registration form and get signed by the Head of the institution and submit it on or before 17-02-2021.

****Participants who are willing for accommodation contact work shop coordinator.****

Distance from

Airport: 9 km

Railway Station: 12 km

New Bus Station: 9 km





K.S.R.M. COLLEGE OF ENGINEERING

(UGC-AUTONOMOUS)

Kadapa, Andhra Pradesh, India- 516 003

Approved by AICTE, New Delhi & Affiliated to JNTUA, Ananthapuramu.

An ISO 14001:2004 & 9001: 2015 Certified Institution



Date: 18-02-2021

Name of the Event : A Three Day Workshop On Catia In Association With "DASSAULT SYSTEMS"

Venue : Engineering Graphics and Design lab

List of Participants

S.No	Name	Department	Contact No	Email Id	Signature
1	Sri. K. Suresh Kumar, Assoc. Professor	MED	7799425286	Sureshace@krmce.ac.in	K.Sun.
2	Dr.B.Sudharshan, Assoc. Professor	MED	9885393585	Sudharshan@krmce.ac.in	B. Sudharshan
3	Dr.P.Bhanu Prakash, Asst. Professor	MED	9985263110	bhanuplem@gmail.com	B.P.
4	Sri. R.R.K. Reddy, Assoc. Professor	MED	9690633226	rrk@krmce.ac.in	RRK
5	Dr. A. Saravan, Professor	MED	8072163168	saravana@krmce.ac.in	A. Saravan
6	Dr.B.Dhrama lingam, Asst. Professor	Med	9849387705	belon@gmail.com	belon
7	Sri. C. Nagaraja, Asst. Professor	MED	9989628777	cnranga@krmce.ac.in	C. Nagaraja
8	Dr. P. Srinivas, Asst. Professor	med	9849056800	Srinivas.P@gmail.com	P. Srinivas
9	Sri.A. Hari Krishna, Asst. professor	MED	9052731415	Harikrishna.P@gmail.com	A. Hari Krishna
10	Sri A.Saroj	MED	9966914925	sarojumar3@gmail.com	Saroj
11	S..Raja sekhar	med	9866915436	rajaSekhar94@gmail.com	Raja Sekhar
12	Sri. S. VijayaKumar, Asst. Professor	MED	9441287880	Sudarsi@gmail.com	S. Vijaya Kumar

13	Sri.U.Pradeep Kumar, Asst. Professor	MED	9908864887	pradeep@ksrmce.ac.in	<i>[Signature]</i>
14	Sri. B. Srihari, Asst. Professor	MED	9493351896	bsh@ksrmce.ac.in	<i>[Signature]</i>
15	Sri.P.Siva Seshu, Asst. Professor	MED	9398151350	Seshudarling@gmail.com	<i>[Signature]</i>
16	Sri.S.Mahaboob Khan, Asst. Professor	MED	9642531366	khan@ksrmce.ac.in	<i>[Signature]</i>
17	Sri.P.K.Chaitanya Kanth Reddy, Asst. Professor	MED	8897920251	chaitupottipati@gmail.com	<i>[Signature]</i>
18	Sri.S.Khasim peera	MED	9966367576	khasimpeera@gmail.com	<i>[Signature]</i>
19	Sri.A.Sanjeev	MED	964291222	sanjeevsai@gmail.com	<i>[Signature]</i>
20	Sri.D.Merwin Rajesh, Asst. Professor	MED	6301096070	Rajulmda@ksrmce.ac.in	<i>[Signature]</i>
21	Sri.T.Naresh, Asst. Professor	MED	9941220375	nareshn57@gmail.com	<i>[Signature]</i>
22	Sri.M.Veeranjaneyulu, Asst. Professor	MED	9494080936	gediherish@gmail.com	<i>[Signature]</i>
23	Sri.p.Harish, Asst. Professor	MED	9703008932	harishpanjalla@gmail.com	<i>[Signature]</i>
24	Dr.D.Ravikanth, Professor	MED	9440506820	doddaravi2007@gmail.com	<i>[Signature]</i>
25	Sri.T.Raja sekhar, Asst. Professor	MED	9944537552	rajasekhar15@gmail.com	<i>[Signature]</i>

V. S. S. Muthy

WORKSHOP CO-ORDINATORS

M.MOHANREDDY, Asst. Professor *[Signature]*
 J.SURESH BABU, Asst. Professor *[Signature]*

Principal
PRINCIPAL
 K.S.R.M. COLLEGE OF ENGINEERING
 KADAPA - 516 003. (A.P.)



K.S.R.M. COLLEGE OF ENGINEERING

(UGC-AUTONOMOUS)

Kadapa, Andhra Pradesh, India- 516 003



Approved by AICTE, New Delhi & Affiliated to JNTUA, Ananthapuramu.

An ISO 14001:2004 & 9001: 2015 Certified Institution

DEPARTMENT OF MECHANICAL ENGINEERING

A Three Day Workshop On Catia In Association With "DASSAULT SYSTEMS"

Detailed schedule for a total of 18 hrs course

SNO	DATE	TOPIC	NO.OF HOURS
1	18.02.2021 F.N	CATIA as a CAD software :- Concept of Parametric Modeling, Feature Based Modeling, User Interface, Mouse operations, File types and Management, drawing profiles. Major user industries of Catia. Why Catia is preferred?	3 HRS
2	18.02.2021 A.N	Sketcher: Profile toolbar, operation (corner, chamfer, relimitations, transformations, project 3D element), constraints, types of constraints, workbench. 3 Sketcher:- sketch tools, tools (Sketch solving status, sketch analysis, output feature), visualization toolbar, user selection filter	3 HRS
3	19.02.2021 F.N	PART DESIGN Modeling of Machined component, Material Addition and Removal (Pad, Pocket, Shaft, Groove), Sketch and Positioned Sketch, Types of Fillets, Types of Chamfer, Types of Hole. Modeling of Machined component - 2. Pattern (Rectangular, Circular, User), Thread/Tap, Datum Features (Plane, Axes, Points), Simple Draft. Frequently used commands for Machined components in Catia / Creo	3 HRS

4	19.02.2021 A.N	Advance Design features :- Axis System, Types of draft, Shell, Stiffener, rib slot, Multisection solid, Removed multisection solid, Apply Material, Measure, Render. advanced commands used in part design Practice on simple machine part drawing part design Of flange coupling	3 HRS
5	20.02.2021 F.N	ASSEMBLY AND DRAFTING Introduction to Assembly:- Types of assembly approach, Types of Constrains and DOF, placement of components in the Assembly, Manipulating Components assembly of stuffing box and screw jack	3 HRS
6	20.02.2021 A.N	Introduction To Drafting & Detailing Theory:- (types Generative – Interactive), Initial Drafting setting, Sheet Background, Views (ortho, ISO), Dimensions (TypesGenerate Dimension & Create Dimension). 11 Views:- (Aux, Section, Details, Clipping, Broken), View properties, DATUMS & Tolerance 12 Annotations:- GD & T, Symbols, Note, Leaders, Table, Symbols (Machining, Roughness, , Custom), Dress-up Toolbar. Practice on simple examples.	3 HRS

WORKSHOP CO-ORDINATORS

M.MOHANREDDY, Asst. Professor

Mohann

J.SURESH BABU, Asst. Professor

Suresh

W. Srinivas
HOD

Professor & head
Department of Mechanical Engineering
K.S.R.M. College of Engineering
KADAPA - 516 003.



K.S.R.M. COLLEGE OF ENGINEERING (UGC-AUTONOMOUS)

Kadapa, Andhra Pradesh, India- 516 003

Approved by AICTE, New Delhi & Affiliated to JNTUA, Ananthapuramu.

An ISO 14001:2004 & 9001: 2015 Certified Institution



Department of Mechanical Engineering Course Feedback Form

Course Title: A Threeday workshop on CATIA

Dates: 18-02-2021 to 20-02-2021 · Venue: Engineering Graphics and Design Lab

Please Fill the short questionnaire to Make the the course better in future

THE DESIGN OF THE COURSE

A. Were objectives of the course clear to you Y N

B. The Course contents met with your Expectations

Strongly Disagree Disagree Agree Strongly Agree

C. The Lecture Sequence was well Planned

Strongly Disagree Disagree Agree Strongly Agree

D. The Contents were illustrated with adequate Examples

Strongly Disagree Disagree Agree Strongly Agree

E. The Level of the Course was

Strongly Disagree Disagree Agree Strongly Agree

F. The course contents met with your Expectations

Strongly Disagree Disagree Agree Strongly Agree

G. Will you Recommend this course to others?

Not at All Recommend

THE CONDUCT OF THE COURSE

A. The Lectures were clear and easy to understand

Strongly Disagree Disagree Agree Strongly Agree

B. The Teaching aids were effectively used

Strongly Disagree Disagree Agree Strongly Agree

C. The course material handed out was adequate

Strongly Disagree Disagree Agree Strongly Agree

D. The instructors encouraged interaction and were helpful

Strongly Disagree Disagree Agree Strongly Agree

E. Were objectives of the course Realized

Yes No

F. Please Give overall rating of the course

90% -100% () 60% -70% ()
80% -90% () 50% -60% ()
70% -80% () below 50 % ()

G. Please comment on the strengths of the course and the way it was conducted

H. Please comment on the weakness of the course and the Way it was conducted

I. Please give suggestions for the improvement of the course

Optional: Name and contact Details

Thank You!!!



K.S.R.M. COLLEGE OF ENGINEERING

(UGC-AUTONOMOUS)

Kadapa, Andhra Pradesh, India- 516 003

Approved by AICTE, New Delhi & Affiliated to JNTUA, Ananthapuramu.

An ISO 14001:2004 & 9001: 2015 Certified Institution



CATIA

PART DRAWING

FLANGE- COUPLING

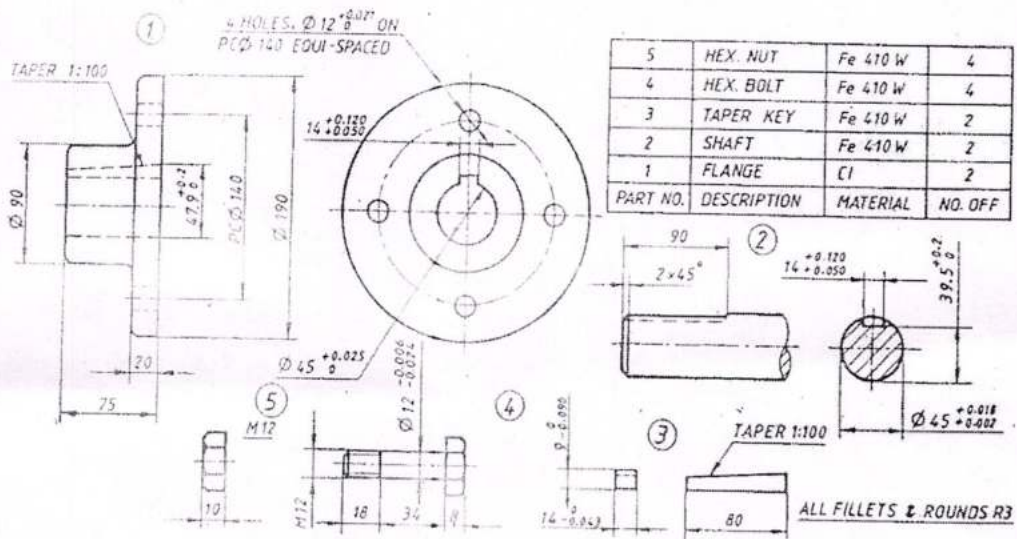

All Dimensions in mm
Details of Flanged Coupling — Unprotected Type

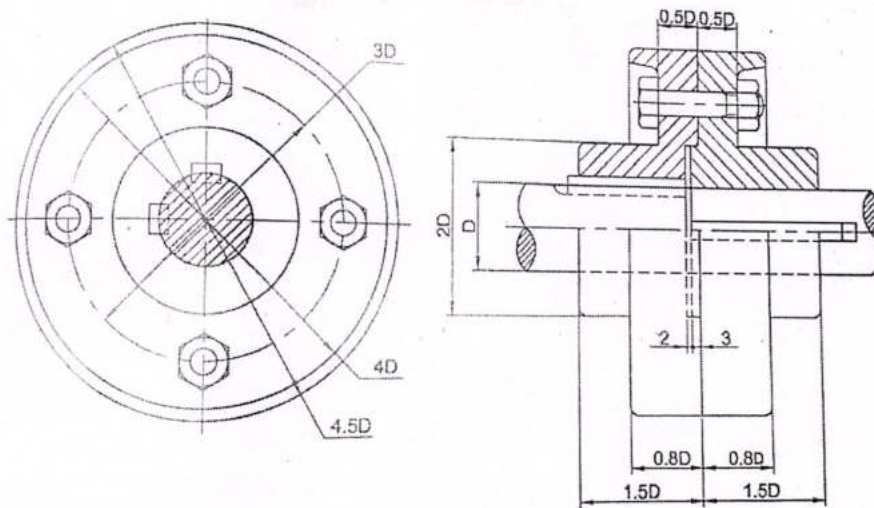
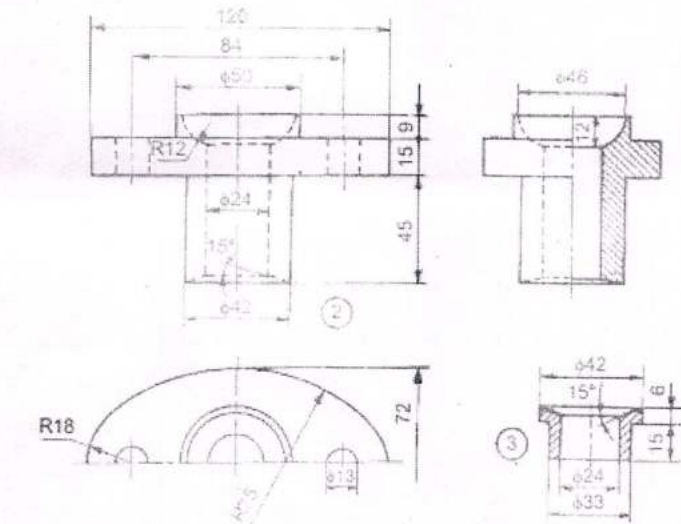
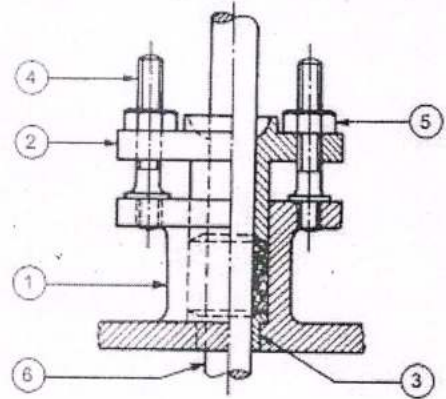
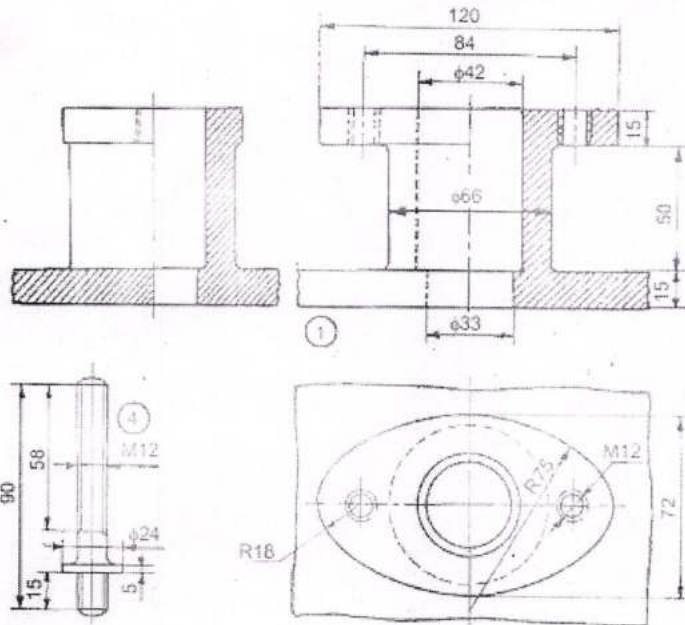

Fig. 8.3 Two Views of Protected Type Flange Coupling

PART DRAWING AND ASSEMBLY OF STUFFING BOX



Parts list

Part No.	Name	Matl	Qty
1	Body	CI	1
2	Gland	Brass	1
3	Bush	Brass	1
4	Stud	MS	2
5	Nut, M12	MS	2

Assembly of SCREW JACK

DETAILS OF SCREW JACK

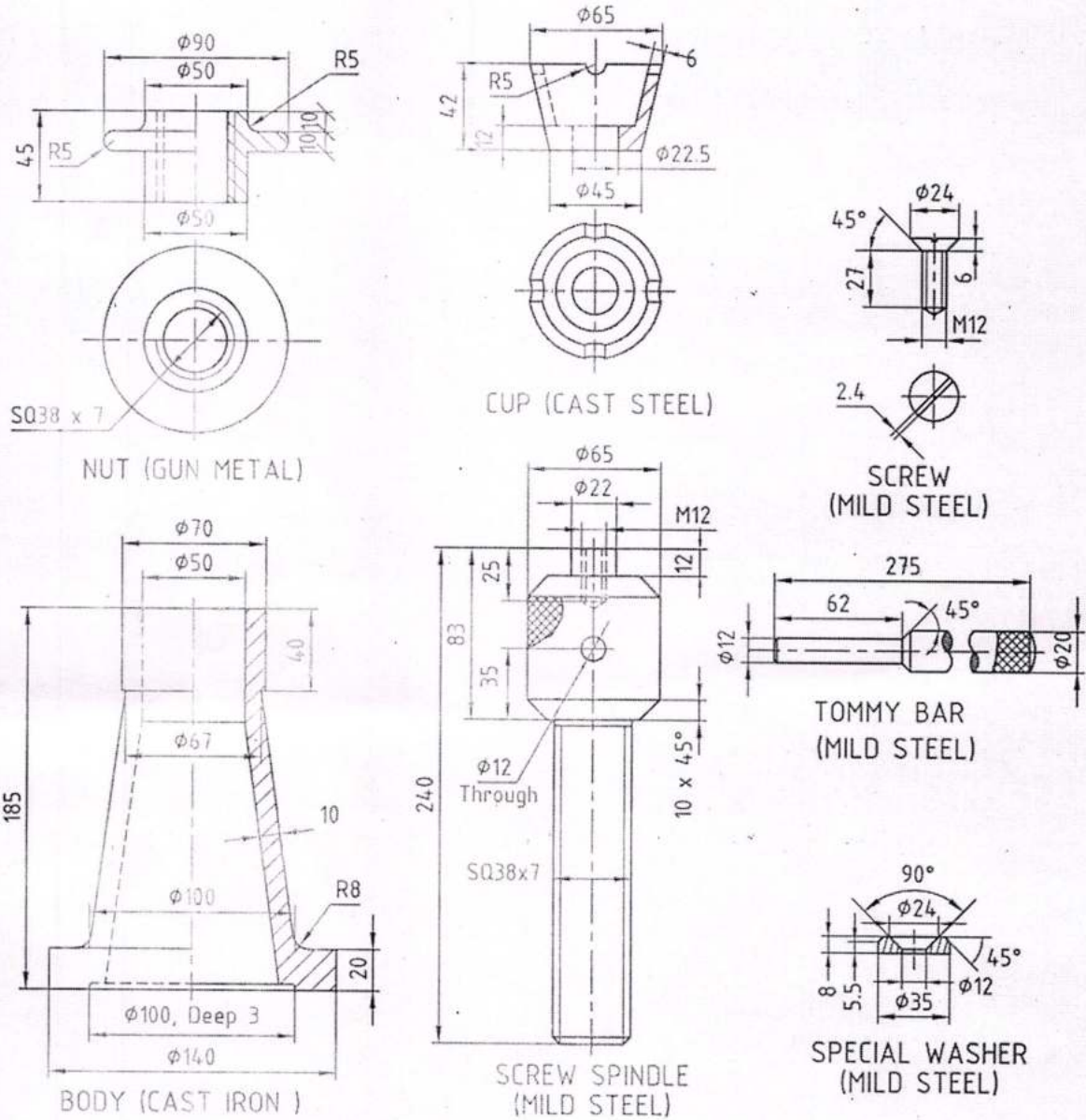

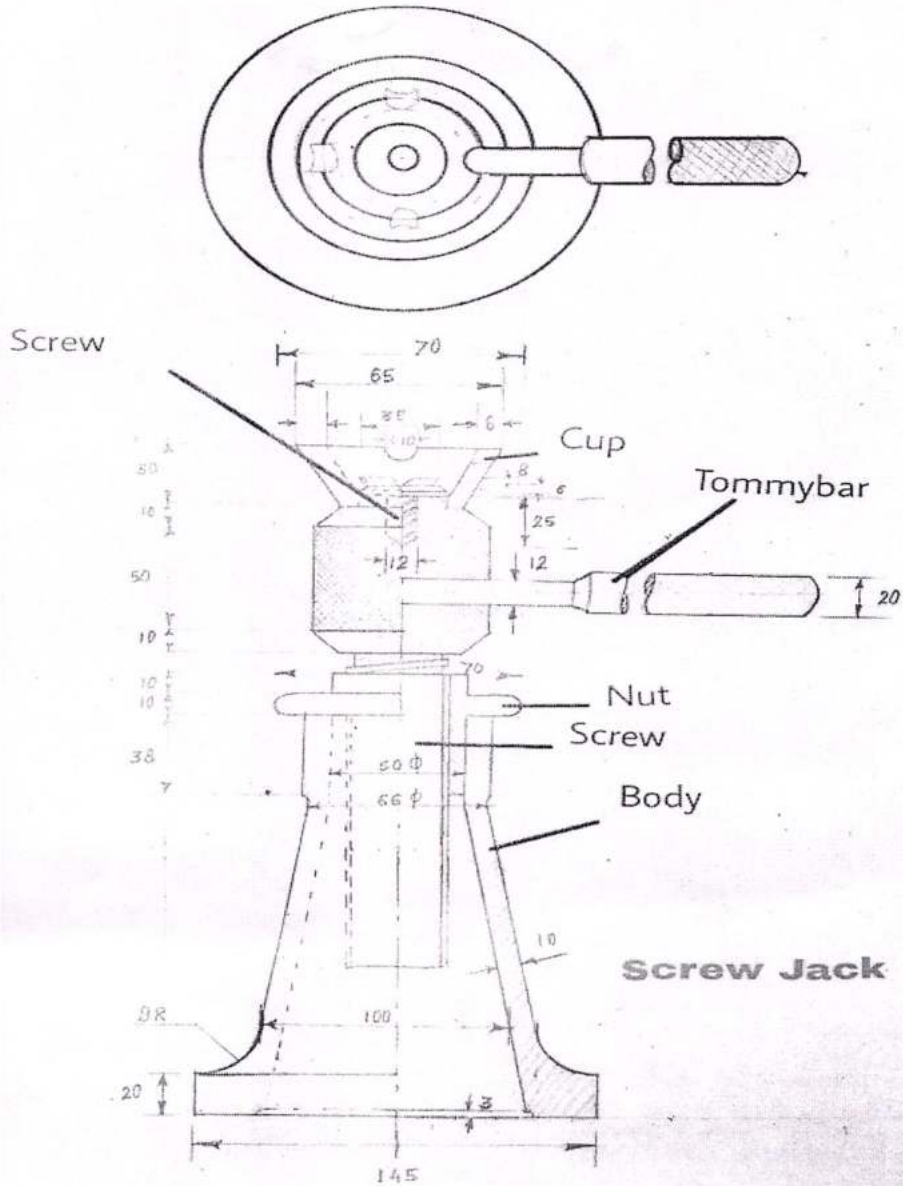

COURSE CO ORDINATORS

M.MOHANREDDY, Asst. Professor

Mohanan

J.SURESH BABU, Asst. Professor

Suresh

W. S. Suresh
HOD

Professor & head
Department of Mechanical Engineering
K.S.R.M. College of Engineering
KADAPA - 516 003.

K.S.R.M. COLLEGE OF ENGINEERING, KADAPA

(An Autonomous Institution)

(Approved by AICTE, Accredited by NAAC, Affiliated To JNTUA, Ananthapuramu)
(An ISO 9001:2015 Certified Institution)



*A Three - Day workshop on
CATIA*

In Association with "DASSAULT SYSTEMS"

18th - 20th February, 2021.

Certificate

This is to certify that Mr./[✓]Ms./Dr./Prof. R. Mahesh, Asst. Professor, M.E.D.
has participated in the Three - Day workshop on CATIA In Association with "DASSAULT SYSTEMS"
Organized by Department of Mechanical Engineering during 18th - 20th of February, 2021.

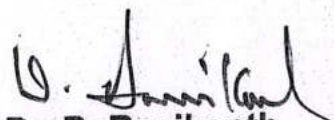
Dr. D. Ravikanth
H.O.D.

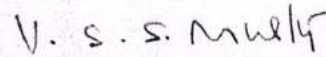
Dr. V.S.S. Murthy
Principal



K.S.R.M. COLLEGE OF ENGINEERING
(UGC-AUTONOMOUS)

Kadapa, Andhra Pradesh, India- 516 003

Approved by AICTE, New Delhi & Affiliated to JNTUA, Ananthapuramu.

An ISO 14001:2004 & 9001: 2015 Certified Institution

Lr./KSRMCE/ (Humanities & Sciences)/2019-20

Date: 24.08.2019

To
The Principal,
K.S.R.M. College of Engineering
Kadapa.

From
M.C. Sanjeevaiah,
Assistant Professor,
Department of H&S,
K.S.R.M College of Engineering
Kadapa.

Respected Sir,

Sub: KSRMCE - (Department of H&S) Permission to organize Workshop on Leadership Management on 28-08-2019 -Reg.

It is being brought to your kind notice that, with reference to the cited, the H&S Department is planning to organise **Workshop on Leadership Development on 28-08-2019 in Civil Seminar Hall**. In regard I kindly request you sir to grant permission to organise this event. This is submitted for your kind perusal.

Thanking you Sir,

Yours Faithfully

M.C. Sanjeevaiah,
Asst. professor,
Dept. of H&S,
K.S.R.M.C.E.

*Forwarded to
Principal Mr.
Dept. of H&S.*

*Permitted
V. S. S. Murthy
27/08/2019*



K.S.R.M. COLLEGE OF ENGINEERING

(UGC-AUTONOMOUS)

Kadapa, Andhra Pradesh, India- 516 003

Approved by AICTE, New Delhi & Affiliated to JNTUA, Ananthapuramu.

An ISO 14001:2004 & 9001: 2015 Certified Institution

Cr./KSRMCE/(Department of H&S)/2019-20

Date:26-08-2019

Circular

All the Students are here by informed that Department of H&S is going to organize **Workshop on Leadership Development on 28-08-2019 in Civil Seminar Hall at 10.00 AM.** In this regard, Students who are interested are instructed to attend the program without fail.

For any queries Contact,

Coordinator

M.C. Sanjeevaiah,
Asst. Prof,
Dept. of H&S
Contact No:9966828805

HOD/H&S

Dr. I. SREEVANI M.Sc., Ph.D.
Head of Humanities & Sciences
KSRM College of Engineering
KADAPA 516 005

Copy to all HoD's for information and with request to circulate among students.

Copy to the Director's Table.

Copy to the Office File.



K.S.R.M. COLLEGE OF ENGINEERING

(UGC - Autonomous)

Kadapa, Andhra Pradesh, India- 516 003

Approved by AICTE, New Delhi & Affiliated to JNTUA, Ananthapuramu.

DEPARTMENT OF HUMANITIES AND SCIENCES

Workshop on " Leadership Development "

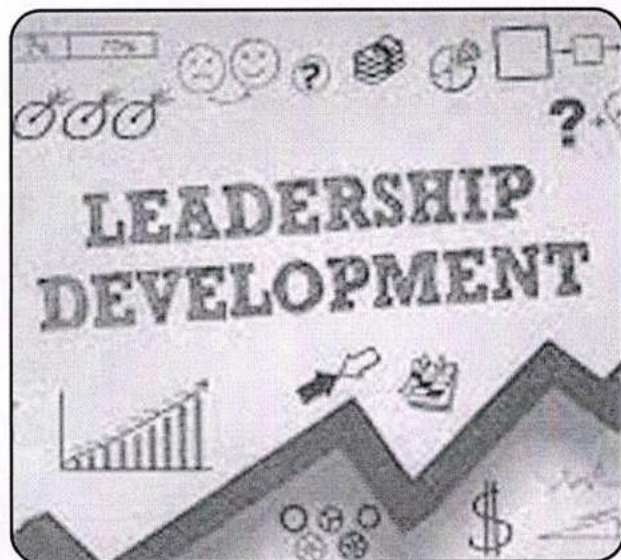

Date Of Event

28-08-2019

10.00 am to 4.00 pm

Coordinator

Sri. M.C. Sanjeevaih,
Asst. Prof, Dept. of H&S

Sri. K.Khasimpeera,
Asst. Prof, Dept. of H&S

Venue

**Civil Seminar
Hall**

Speaker

Dr. G. Ashok Reddy,
Asst. Prof, KSRM
College of Management
Studies, Kadapa.

Dr. I. Sreevani
(Convener & HOD H&S)

Dr.V.S.S. Murthy
(Principal)

Prof. A. Mohan
(Director)

Sri K. Sivananda Reddy
(Correspondent)



K.S.R.M. COLLEGE OF ENGINEERING (UGC-AUTONOMOUS)

Kadapa, Andhra Pradesh, India- 516 003

Approved by AICTE, New Delhi & Affiliated to JNTUA, Ananthapuramu.

An ISO 14001:2004 & 9001: 2015 Certified Institution

Date: 28-08-2019

Name of the Event: Workshop on Leadership ~~Development~~ Development

Venue : Civil Seminar Hall

List of Participants

S.NO	Name	Branch	Contact Number	Signature
1	D. Murthy	ECE	9381239585	Murthy.
2	P. Pawan	ECE	7286891794	P. Pawan
3	B. Chetan Reddy	ECE	9492901580	B. Chetan Reddy
4	D. Suresh	ECE	799747447	D. Suresh
5	J. Ajay Kumar	CSE	8096217796	J. Ajay
6	N. Hari Obulesu	ME	9553602092	N. Hari Obulesu
7	K. Kiran	ECE	9493962981	K. Kiran
8	N. Karthik	ECE	9502945026	Karthik.N
9	P. Srinivasulu	ECE	7674075523	P. Srinivasulu
10	Salath Kumel	ECE	7780545059	Salath Kumel
11	K. Vennala	CSE	7286978198	K. Vennala
12	P. Obulesu	ECE	7381155228	P. Obulesu.
13	Saikrishore	ECE	9014257886	Saikrishore
14	Phaneendra	CSE	6304739307	Phaneendra
15	S. Saddika	CSE	630546528	S. Saddika
16	A. Anitha	ECE	7075090030	A. Anitha
17	A. Adithya	ECE	9886251177	A. Adithya
18	A. Prem Reddy	ECE	9572892192	A. Prem Reddy.
19	B. Kausalya	ECE	7981415138	Kausalya

20	B. Vijayasree	ECE	9491413188	B. Vijayesee
21	B. Jahnvi	ECE	8919629767	Jahnvi
22	B. Lakshmi Prasanna	ECE	8688623851	Prasanna.
23	C. Charitha	ECE	9121557162	Charitha
24	D. Sivani	ECE	9676562350	D. Sivani
25	D. Prashanka	ECE	6304419541	Prashanka
26	G. Mounika	ECE	6304650473	mounika
27	G. Deepika	ECE	6305532742	Deepika
28	G.J. Sai Prasanna	ECE	7569809867	Sai Prasanna
29	J. Poojitha	ECE	8886704270	J. Poojitha.
30	J. Hemalatha	ECE	6394494271	J. Hemalatha
31	K. Shilpa	ECE	9986247729	K. Shilpa
32	K. Bhavathi	ECE	6301634485	K. Bhavathi
33	K. Divya	ECE	9014473117	K. Divya
34	K. Kiran	ECE	6304614282	Kiran
35	K. Haran	ECE	760102762	haran
36	U. Rahul	ECE	9332226974	Rahul
37	U. Rajesh	ECE	754973118	Rajesh
38	D. Sunesh	ECE	8297651631	Sunesh.
39	E. Mahendra	ECE	935934803	Mahendra

Coordinator

HOD/H&S
Dr. I. SREEVANI M.Sc., Ph.D.
Head of Humanities & Sciences
KSRM College of Engineering
KADAPA - 516 005

Principal
PRINCIPAL
K.S.R.M. COLLEGE OF ENGINEERING
KADAPA-516003, (A.P.)



K.S.R.M. COLLEGE OF ENGINEERING

(UGC-AUTONOMOUS)

Kadapa, Andhra Pradesh, India- 516 003

Approved by AICTE, New Delhi & Affiliated to JNTUA, Ananthapuramu.

An ISO 14001:2004 & 9001: 2015 Certified Institution

Activity Report

Name of the Activity	Workshop on Leadership Management	
Type of Activity	Student Centric Event	
Date and Time of Activity	28-08-2019	10.00 AM - 4:00 PM
Details of Participants	Students(38)	
Coordinator(s)	M.C. Sanjeevaiah , Asst. prof, Dept. of H&S	
Organizing Dept./Support System	Department of Humanities and Sciences	
Description	<p>The Department of Humanities and Sciences organized a one day workshop on Leadership Development on 28th Aug – 2019 in KSRM College of Engineering (Autonomous), Kadapa. The workshop commenced with welcome address by Dr. V.S.S Murthy. On this occasion, he briefed the importance of Leadership Development. Dr. G. Ashok Reddy, Asst Professor of KSRM College of Management Studies, Kadapa acted as the speaker for this workshop. He defined Leadership as a Social process that involves the ability to influence others. For this the students need to learn and acquire Leadership skills such as Communication, Motivation, Delegation, Positivity, Trustworthiness, Creativity, Commitment, Commanding and Flexibility skills. Students should also acquire Leadership abilities and skills by participating in sports and games, social groups, cross cultural groups, seminars and internships. At the end of the program Dr. I. Sreevani HOD, H & S Dept expressed thanks to all the participants. Sri. K. Khasimpeera, Asst. Professor, conveyed a vote of thanks.</p>	



/ksrmce.ac.in

Follow Us:



/ksrmceofficial



Compute Science and Civil Engineering, KSRM Hostel Rd, Andhra Pradesh 516003, India

Latitude **14.476789°** Longitude **78.765504°**

LOCAL 10:10:56 GMT 03:40:56 WEDNESDAY 28.08.2019 ALTITUDE 51 METER

Speaker Dr. G. Ashok Reddy addressing the participants

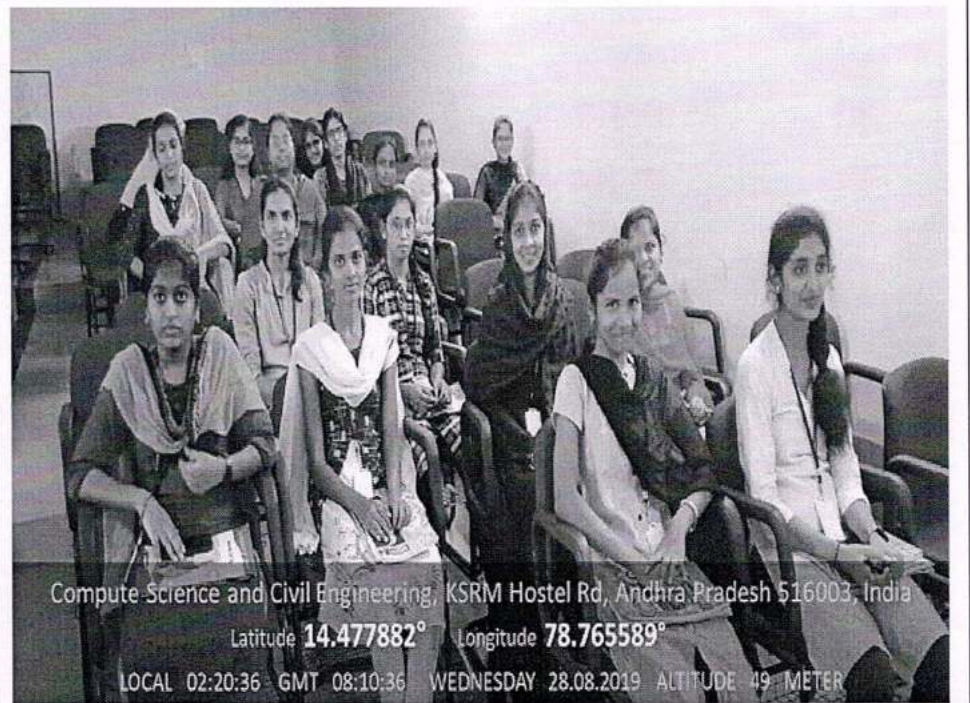

Compute Science and Civil Engineering, KSRM Hostel Rd, Andhra Pradesh 516003, India

Latitude **14.477882°** Longitude **78.765589°**

LOCAL 02:20:36 GMT 08:10:36 WEDNESDAY 28.08.2019 ALTITUDE 49 METER

Participants listening to the speaker



Speaker explaining the leadership qualities

Coordinator

HOD
Dr. I. SREEVANI M.Sc., Ph.D.
Head of Humanities & Sciences
K.S.R.M. College of Engineering
KADAPA - 516 005



K.S.R.M COLLEGE OF ENGINEERING, KADAPA

(Autonomous)

Yerramasupalli, Kadapa, Andhra Pradesh – 516003

Department of Humanities & Sciences

Feedback Form

On

“Workshop on Leadership Management”

38-08-2019

1. The Session has increased my knowledge in the given topic
 Strongly agree Agree Disagree Strongly Disagree

2. Did you find the workshop useful & Interactive
 Yes No

3. The lecture was clear and understanding
 Strongly agree Agree Disagree Strongly Disagree

4. Did you find the speaker interactive during the session
 Strongly agree Agree Disagree Strongly Disagree

5. What is the overall experience of the workshop
 Excellent Good Neutral Not good

Suggestions if any:

Signature of the participant



K.S.R.M COLLEGE OF ENGINEERING, KADAPA
(Autonomous)

Yerramasupalli, Kadapa, Andhra Pradesh – 516003

Department of Humanities & Sciences

Feedback Form

On

“Workshop on Leadership Management”

38-08-2019

1. The Session has increased my knowledge in the given topic
 Strongly agree Agree Disagree Strongly Disagree
2. Did you find the workshop useful & Interactive
 Yes No
3. The lecture was clear and understanding
 Strongly agree Agree Disagree Strongly Disagree
4. Did you find the speaker interactive during the session
 Strongly agree Agree Disagree Strongly Disagree
5. What is the overall experience of the workshop
 Excellent Good Neutral Not good

Suggestions if any: *No*

Divya
Signature of the participant



K.S.R.M COLLEGE OF ENGINEERING, KADAPA
(Autonomous)

Yerramasupalli, Kadapa, Andhra Pradesh – 516003

Department of Humanities & Sciences

Feedback Form

On

“Workshop on Leadership Management”

38-08-2019

1. The Session has increased my knowledge in the given topic
[] Strongly agree [] Agree [] Disagree [] Strongly Disagree
2. Did you find the workshop useful & Interactive
[] Yes [] No
3. The lecture was clear and understanding
[] Strongly agree [] Agree [] Disagree [] Strongly Disagree
4. Did you find the speaker interactive during the session
[] Strongly agree [] Agree [] Disagree [] Strongly Disagree
5. What is the overall experience of the workshop
[] Excellent [] Good [] Neutral [] Not good

Suggestions if any:

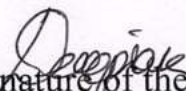
Signature of the participant



K.S.R.M COLLEGE OF ENGINEERING, KADAPA

(Autonomous)

Yerramasupalli, Kadapa, Andhra Pradesh – 516003

Department of Humanities & Sciences

Feedback Form

On

“Workshop on Leadership Management”

38-08-2019

1. The Session has increased my knowledge in the given topic
[] Strongly agree Agree [] Disagree [] Strongly Disagree
2. Did you find the workshop useful & Interactive
[] Yes [] No
3. The lecture was clear and understanding
[] Strongly agree Agree [] Disagree [] Strongly Disagree
4. Did you find the speaker interactive during the session
[] Strongly agree Agree [] Disagree [] Strongly Disagree
5. What is the overall experience of the workshop
[] Excellent [] Good Neutral [] Not good

Suggestions if any:

Signature of the participant



K.S.R.M COLLEGE OF ENGINEERING, KADAPA

(Autonomous)

Yerramasupalli, Kadapa, Andhra Pradesh – 516003

Department of Humanities & Sciences

Feedback Form

On

“Workshop on Leadership Management”

38-08-2019

1. The Session has increased my knowledge in the given topic
 Strongly agree Agree Disagree Strongly Disagree

2. Did you find the workshop useful & Interactive
 Yes No

3. The lecture was clear and understanding
 Strongly agree Agree Disagree Strongly Disagree

4. Did you find the speaker interactive during the session
 Strongly agree Agree Disagree Strongly Disagree

5. What is the overall experience of the workshop
 Excellent Good Neutral Not good

Suggestions if any:

F. Mahender
Signature of the participant



K.S.R.M. COLLEGE OF ENGINEERING
(UGC-AUTONOMOUS)

Kadapa, Andhra Pradesh, India- 516 003

Approved by AICTE, New Delhi & Affiliated to JNTUA, Ananthapuramu.

An ISO 14001:2004 & 9001: 2015 Certified Institution

Lr./KSRMCE/ (ECE)/2019-20/

Date: 07-10-2019.

To

The Principal,
K.S.R.M. College of Engineering
Kadapa.

Respected Sir,

Sub: KSRMCE – ECE –“Guest Lecture on” AI APPLICATIONS IN SIGNAL PROCESSING” –
Requested - Reg.

The ECE department is going to organize a “Guest Lecture on AI APPLICATIONS IN SIGNAL PROCESSING” on 10-10-2019. In this regard I kindly request you to permit us, to organize the same.

Thanking you sir,

Yours Faithfully

Sri. K.Pavan kumar
Asst. Professor, ECE

*Forwarded to the
Principal sir
S.H.*

*Permitted
V.S.S. Mm/4
07/10/2019*



K.S.R.M. COLLEGE OF ENGINEERING (UGC-AUTONOMOUS)

Kadapa, Andhra Pradesh, India- 516 003

Approved by AICTE, New Delhi & Affiliated to JNTUA, Ananthapuramu.

An ISO 14001:2004 & 9001: 2015 Certified Institution

Cr./KSRMCE/ (Department of E.C.E)/2019-20/

Date: 09-10-2019

CIRCULAR

All the students are hereby informed that the ECE department is going to organize an Guest Lecture on "AI APPLICATIONS IN SIGNAL PROCESSING" on 10.10.2019 at 10.00 am., in SJ seminar hall

In this connection all the students are hereby requested to attend the above programme without fail and make the programme grand success.

HEAD OF THE DEPARTMENT
Professor & M.O.D.
Department of E.C.E.
K.S.R.M. College of Engineering
KADAPA - 516 003.

Cc:

IQAC

KSRMCE



K.S.R.M. COLLEGE OF ENGINEERING

(Autonomous)

Kadapa, Andhra Pradesh, India- 516 003

Approved by AICTE, New Delhi & Affiliated to JNTUA, Ananthapuramu.

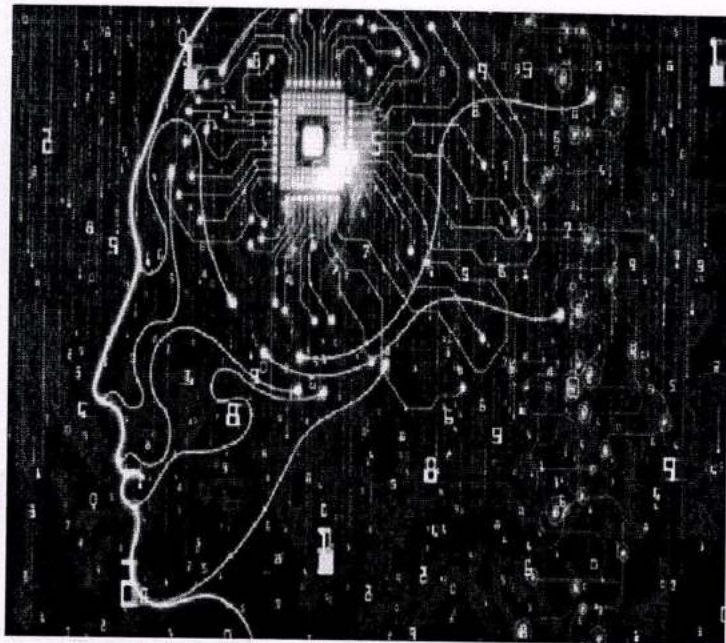

Guest Lecture
“AI APPLICATIONS IN SIGNAL PROCESSING”

Resource person
Dr.N. Sreekanth
Professor, MRCEW, Hyd

Coordinator
Sri. K.Pavankumar
Assistant Professor, ECE

Date **10-10-2019** *Venue* **SJ Seminar Hall**

Sri K. Chandra Obul Reddy Management Member, M.D of K.D.R. Ginning & Oil Mills Pvt. Ltd.	Sri K. Madan Mohan Reddy Vice-Chairman	Sri K. Sivananda Reddy Correspondent	Sri S. Sankar Reddy Chairman	Prof. A. Mohan Director	Prof. V.S.S. Murthy Principal	Dr. G. Hemalettha Professor, HOD,ECE Convener
--	---	---	---------------------------------	----------------------------	----------------------------------	---



K.S.R.M. COLLEGE OF ENGINEERING

(AUTONOMOUS)

Kadapa, Andhra Pradesh, India- 516 003

Approved by AICTE, New Delhi & Affiliated to JNTUA, Ananthapuramu.

An ISO 14001:2004 & 9001: 2015 Certified Institution

ACTIVITY REPORT

Guest Lecture

On

“AI APPLICATIONS IN SIGNAL PROCESSING”

10th October, 2019

Target Group	: Students
Details of Participants	: 48 Students
Resource person	: Dr. N. Sreekanth, Professor, ECE, MRCEW, Hyd
Co-ordinator	: Sri. K. Pavankumar, Assistant Professor, ECE dept
Organizing Department	: Electronics and Communication Engineering
Venue	: SJ seminar hall

Description:

The guest lecture on AI applications in signal processing organized by KS.R.M.C.E, ECE department .Dr. G. Hemalatha (HOD, ECE), presided over the inaugural function. The guest delivered the importance of “Artificial Intelligence applications in signal processing” and given suggestions and ideas for doing projects on signal processing.

Artificial intelligence (AI) offers new opportunities to improve signal processing systems for various real-world signals, such as biomedical and audio. You can use MATLAB products to interactively explore, create, and preprocess data, engineer features, build AI models, and deploy AI systems.

Instead of relying on aggregate features defined by the traditional signal processing tools, Reality AI discovers features directly from the raw sensor signal data in all of its inherent noisiness and complexity. This approach allows for consideration of information in both time and frequency domains, and allows for detection of conditions with much more subtle signatures.

Our algorithms are based on patented techniques using mathematics described in the literature as sparse decomposition or sparse coding, as well as a number of other related proprietary techniques. These techniques operate unsupervised or semisupervised to dynamically discover an optimal feature set for describing similarities between signals of the same class and differences between signals of different classes.

Photos:

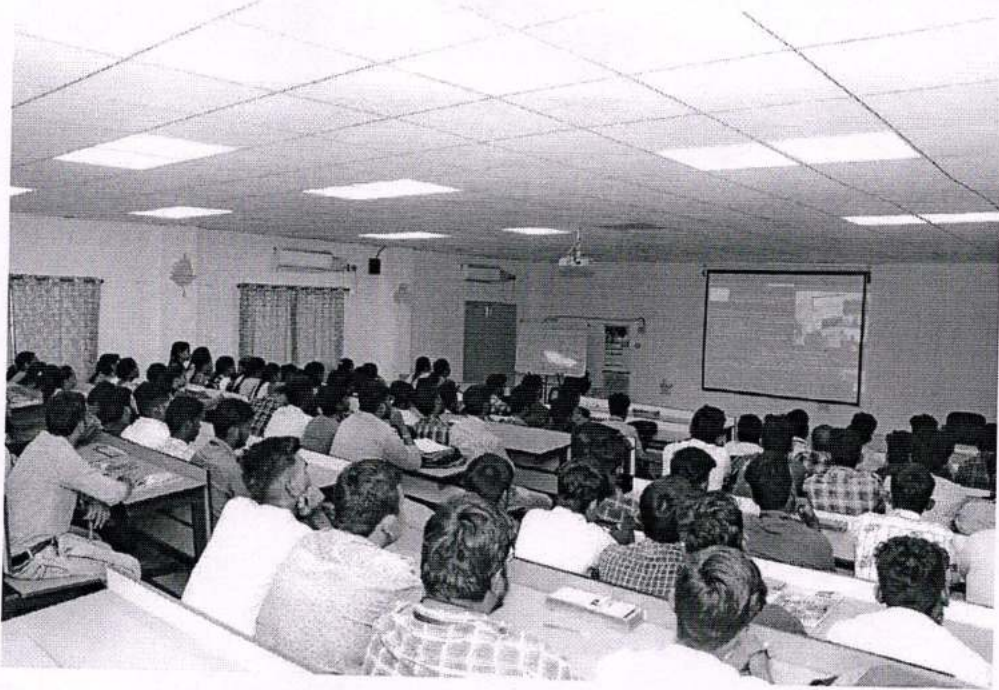

Fig: Resource person addressing the students

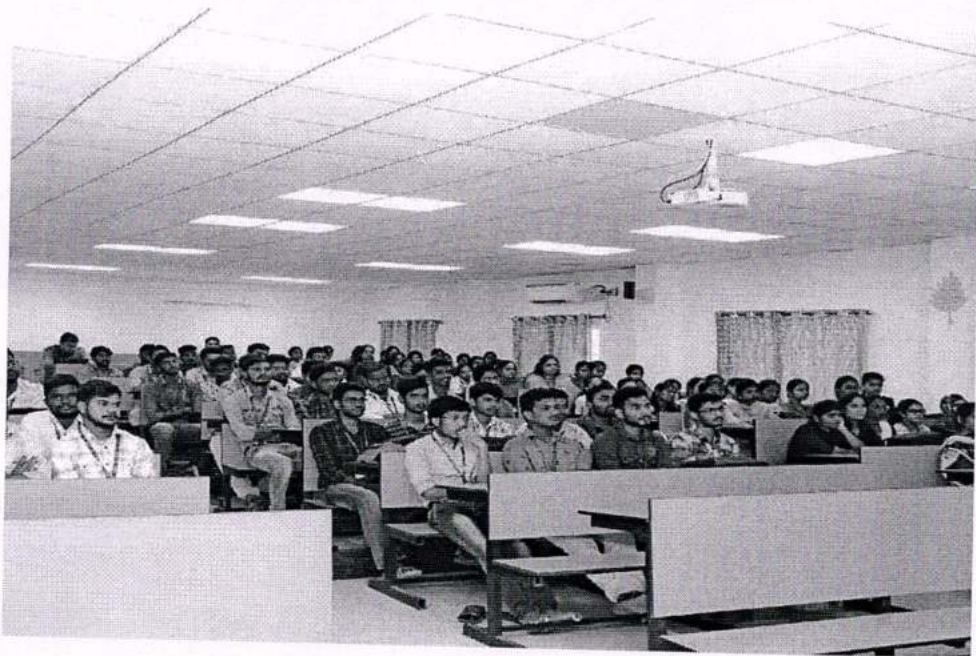
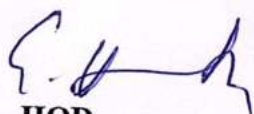

Fig: Students listening the lecture

Coordinator

HOD
Professor & M.O.D.
Department of E.C.E.
R.S.R.M. College of Engineering
KADAPA - 516 083



K.S.R.M. COLLEGE OF ENGINEERING

(UGC-AUTONOMOUS)
Kadapa, Andhra Pradesh, India- 516 003

Approved by AICTE, New Delhi & Affiliated to JNTUA, Ananthapuramu.

An ISO 14001:2004 & 9001: 2015 Certified Institution

Date: 10-10-2019

Name of the Event: Guest Lecture on AI APPLICATIONS IN SIGNAL PROCESSING

Venue: SJ seminar hall

List of Participants

S.No	Roll No.	Name	Email Id	Signature
1	179Y1A04C0	shaik mohammed sharif	179Y1A04C0@ksrmce.ac.in	S. moham
2	179Y1A04C1	shaik noor mohammed	179Y1A04C1@ksrmce.ac.in	S. noor mohammed
3	179Y1A04C2	shaik shavalli	179Y1A04C2@ksrmce.ac.in	S. shavalli
4	179Y1A04C3	shaik tanveer	179Y1A04C3@ksrmce.ac.in	shaik
5	179Y1A04C4	S. Sai Akhila	179Y1A04C4@ksrmce.ac.in	S. Sai Akhila
6	179Y1A04C5	S. Preethi	179Y1A04C5@ksrmce.ac.in	S. Preethi
7	179Y1A04C6	S. PUSHPA Latha	179Y1A04C6@ksrmce.ac.in	PUSHPA
8	179Y1A04C7	S. Ammadhe	179Y1A04C7@ksrmce.ac.in	Amma
9	179Y1A04C8	S. Seemabhanu	179Y1A04C8@ksrmce.ac.in	Seema
10	179Y1A04C9	T. Venkateswar	179Y1A04C9@ksrmce.ac.in	T. Venkateswar
11	179Y1A04D0	T. Davan Kumar	179Y1A04D0@ksrmce.ac.in	T. Davan Kumar
12	179Y1A04D1	T. Prashanth	179Y1A04D1@ksrmce.ac.in	T. Prashanth
13	179Y1A04E3	Y. Keerthi	179Y1A04E3@ksrmce.ac.in	Keerthi
14	179Y1A04E1	YV Bharath	179Y1A04E1@ksrmce.ac.in	Bharath
15	179Y1A04D4	V. Nagaraju	179Y1A04D4@ksrmce.ac.in	V. Nagaraju
16	179Y1A0492	O. Swathi	179Y1A0492@ksrmce.ac.in	Swathi
17	169Y1A0457	K. Vinay Kumar	169Y1A0457@ksrmce.ac.in	Vinay Kumar
18	179Y1A04D6	V. Harsha	179Y1A04D6@ksrmce.ac.in	Harsha
19	169Y1A0463	M. Moufiker	169Y1A0463@ksrmce.ac.in	Moufiker
20	179Y1A04D7	V. Bhaskar	179Y1A04D7@ksrmce.ac.in	Bhaskar
21	179Y1A04E5	Y. Sweetha	179Y1A04E5@ksrmce.ac.in	Sweetha

S.No	Roll No.	Name	Email Id	Signature
22	17941A04E2	Y. Sai vidya	17941a04e2@ksrmce.ac.in	
23	17941A04D5	V. Siddafah	17941A04d5@ksrmce.ac.in	
24	16941A0435	G. Anusha	16941A0435@ksrmce.ac.in	
25	17941A0492	O. Swathi	17941A0492@ksrmce.ac.in	
26	17941A04A6	P. Vijaya Vani	17941A04a6@ksrmce.ac.in	
27	17941A04B3	U. Bhavija Sree	17941A04b3@ksrmce.ac.in	
28	17941A0454	P. Nazma	17941A0454@ksrmce.ac.in	
29	16941A0456	M. Radha	16941A0456@ksrmce.ac.in	
30	16941A0467	M. Lokesh	16941A0467@ksrmce.ac.in	
31	17941A04E6	S. Harsha	17941a04e6@ksrmce.ac.in	
32	16941A0445	K. Chandana	16941A0445@ksrmce.ac.in	
33	16941A0449	K. Linga Reddy	16941A0449@ksrmce.ac.in	
34	16941A0468	N. Amaraswara Reddy	16941A0468@ksrmce.ac.in	
35	17941A04D9	V. Bhavani	17941a04d9@ksrmce.ac.in	
36	17941A04A6	P. Vijaya Vani	17941A04A6@ksrmce.ac.in	
37	16941A0465	M. Rama Sunil	16941A0465@ksrmce.ac.in	
38	16941A0462	M. Harshavardhan Reddy	16941A0462@ksrmce.ac.in	
39	17941A04E4	Y. Sasidhar	17941A04e4@ksrmce.ac.in	
40	17941A04B7	S. Fuzal	17941A04B7@ksrmce.ac.in	
41	17941A04B3	R. Charan Kumar	17941A04B3@ksrmce.ac.in	
42	16941A0464	M. Sreedhar	16941A0464@ksrmce.ac.in	
43	16941A0455	M. Mohan Karshua	16941A0455@ksrmce.ac.in	
44	17941A04E0	V. Reena	17941A04e0@ksrmce.ac.in	
45	17941A04D2	U. Gangakiran	17941A04d2@ksrmce.ac.in	
46	17941A0449	K. Saiteja	17941A0449@ksrmce.ac.in	
47	17941A0444	K. Gurrappa	17941A0444@ksrmce.ac.in	
48	17941A04D8	V. Dastagiri	17941A04d8@ksrmce.ac.in	
49	17941A04B2	S. Tubeer	17941A04B2@ksrmce.ac.in	

Coordinator



K.S.R.M. COLLEGE OF ENGINEERING

(UGC-AUTONOMOUS)

Kadapa, Andhra Pradesh, India- 516 003

Approved by AICTE, New Delhi & Affiliated to JNTUA, Ananthapuramu.

An ISO 14001:2004 & 9001: 2015 Certified Institution

Lr./KSRMCE/ (Humanities & Sciences)/2019-20

Date: 25.10.2019

To
The Principal,
K.S.R.M. College of Engineering
Kadapa.

From
A. Anand rao
Assistant Professor,
Department of H&S,
K.S.R.M College of Engineering
Kadapa.

Respected Sir,

Sub: KSRMCE - (Department of H&S) Permission to organize seminar on Power of Body Language on 31-10-2019-Reg

It is being brought to your kind notice that, with reference to the cited, the H&S Department is planning to organise **Seminar entitled " Power of Body Language" on 31-10-2019 in Civil Seminar Hall.** In this regard I kindly request you sir to grant permission to organise this event. This is submitted for your kind perusal.

Thanking you Sir,

Yours faithfully

A. Anand Rao,
Asst. professor,
Dept. of H&S,
K.S.R.M.C.E.

*Forwarded to
Principal
Dept of H&S.*

*Permitted
U. S. S. Mm/5*



K.S.R.M. COLLEGE OF ENGINEERING
(UGC-AUTONOMOUS)

Kadapa, Andhra Pradesh, India- 516 003

Approved by AICTE, New Delhi & Affiliated to JNTUA, Ananthapuramu.

An ISO 14001:2004 & 9001: 2015 Certified Institution

Cr./KSRMCE/(Department of H&S)/2019-20

Date:26-10-2019

Circular

All the I. B. Tech students are here by informed that Department of H&S is going to organize **seminar on Power of Body Language on 31-10-2019 in Civil Seminar at 3.00 pm**. In this regard interested students are here by instructed to attend the program without fail.

For any queries Contact,

Coordinator

A. Anand Rao,
Asst. Prof,
Dept. of H&S
Contact No: 8019023054

HOD, H&S

Dr. I. SREEVANI M.Sc., Ph.D.
Department of Humanities & Sciences
K.S.R.M. College of Engineering
KADAPA - 516 005

Copy to all the HoD's for information and with a request to circulate among students.

Copy to the Director's Table.

Copy to the Office File.



K.S.R.M. COLLEGE OF ENGINEERING

(UGC - Autonomous)

Kadapa, Andhra Pradesh, India- 516 003

Approved by AICTE, New Delhi & Affiliated to JNTUA, Ananthapuramu.

DEPARTMENT OF HUMANITIES AND SCIENCES

Seminar on " Power of Body Language "

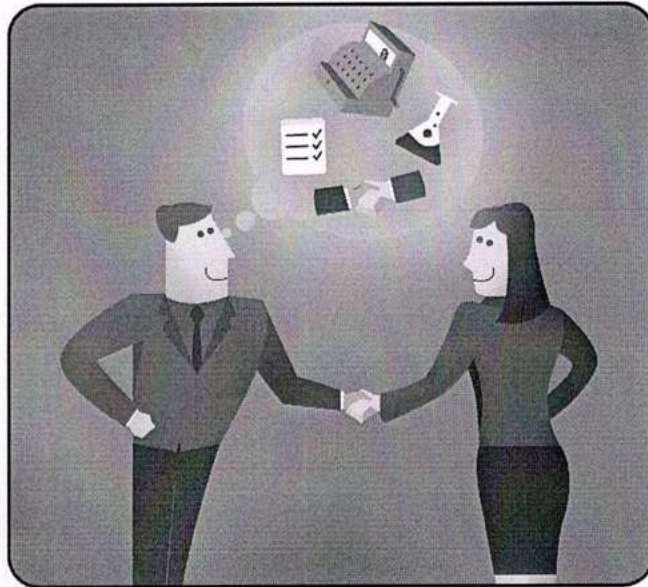

Date Of Event

31-10-2019

3.00 pm to 5.00 pm

Coordinator

Sri. A. Anand Rao,
Asst. Prof, Dept. of H&S

Venue

**Civil Seminar
Hall**

Speaker

Sri. K. Eswara Reddy
Asst. Prof, Dept. of H&S

Dr. I. Sreevani
(Convener & HOD H&S)

Dr. V.S.S. Murthy
(Principal)

Prof. A. Mohan
(Director)

Sri K. Sivananda Reddy
(Correspondent)



K.S.R.M. COLLEGE OF ENGINEERING

(UGC-AUTONOMOUS)

Kadapa, Andhra Pradesh, India- 516 003

Approved by AICTE, New Delhi & Affiliated to JNTUA, Ananthapuramu.

An ISO 14001:2004 & 9001: 2015 Certified Institution

Date: 30-10-2019

Name of the Event: Power of Body Language

Venue : Civil seminar Hall

List of Participants

S.NO	Name	Branch	Contact Number	Signature
1	Guduru Imran	C.S.E	6301881013	G.Imran
2	B. Satish	CSE	9581229564	Satish
3	B-Dineswar Reddy	CSE	9390037232	B.Dineswar
4	D. Lingaraj	CSE	7589610020	D.Ling
5	D. Kasim Hussain	CSE	7013784682	Kasim
6	G.N. Kishor	CSE	9885162177	Kishor
7	C. Sudheer babu	CSE	7075602605	C.Sudheer
8	A. Mahesh kumar	CSE	8688127142	A.Mahesh
9	A.S. Jitheswar Reddy	CSE	9440137260	A.S.Jitheswar
10	B. Adarsh	CSE	7993797729	Adarsh
11	A. Praveen Kumar	CSE	7093348963	A.Praveen
12	A. Lakshmi Narasimha	CSE	6281166935	A.Lakshmi
13	C. Rahulvardhan	CSE	9550845924	C.Rahul
14	D. Vanjeer kumar	CSE	9347200081	D.Vanjeer
15	G. Dilcep kumar	CSE	9390588114	Dilcep
16	G. Siva Kumar	CSE	9893957445	Siva
17	D. Sudharshan	CSE	9515788781	Sudharshan
18	D. Harikishan	CSE	9642739456	Harikishan

19	G. V. Trishan	CSE	6305756894	G. V. Trishan
20	A. Pawan Kalyan	CSE	9390061106	A. Pawan
21	A. Ananthan Reddy	CSE	8106697699	A. Ananthan
22	B. Hema Sai	CSE	9110522040	B. Hema Sai
23	E. Mounika	CSE	6301634475	E. Mounika
24	G. Aruna	CSE	9515518896	Aruna
25	B. Chaitanya	CSE	9347929349	Chaitanya
26	B. Sivachandrika	CSE	8688947709	B. Siva chandrika
27	D. Growthani	CSE	7569809865	D. Growthani
28	D. Ekshitha Rekha	CSE	9014051523	D. Ekshitha Rekha
29	J. Nayya Chanitha	CSE	6304419513	J. Nayya Chanitha
30	C. Aruna	CSE	6305494271	C. Aruna
31	G. Yashoda	CSE	6305532753	Yashoda
32	C. Bhargavi	CSE	6304650163	C. Bhargavi
33	E. Prasanna	CSE	8886704720	E. Prasanna
34	B. Pravalika	CSE	8688336031	B. Pravalika
35	C. Taya Sma	CSE	9014127163	C. Taya
36	V. Sandhya Rani	CSE	8281914836	V. Sai
37	C. Dhareani	CSE	8688623861	Dhareani
38	B. Anusha	CSE	6304614382	Anu
39	B. Srinikhila	CSE	8978226733	nikhila
40	G. Tejaswini	CSE	7981514138	Tejaswini
41	C. Thulasi	CSE	9491413185	Thulasi
42	A. Rukmini	CSE	86298411467	A. Rukmini
43	K. Keerthi	CSE	6301860205	K. Keerthi
44	K. Shrawani	CSE	9391606069	K. Shrawani
45	K. Jabnavi	CSE	8341453586	K. Jabnavi
46	N. Vandana	CSE	9347645594	N. Vandana
47	N. Sai Madhu Sai	CSE	7893325119	N. Sai Madhu Sai
48	P. Naga Prashanthi	CSE	8790871468	prashanthi pasala
49	N. S. Manogna	CSE	9390923272	N. S. Manogna

50	M.sushma	CSE	9391244481	sushma
51	k. Ram Anusha	CSE	7207344074	k. Ram
52	k. Pavani	CSE	9640470067	k. Pavani
53	k. Rajamma	CSE	9390913664	k. Rajamma
54	M. Madhuri	CSE	6302027768	M. Madhuri
55	k. kusuma	CSE	9391866121	kusuma
56	M. Keerthana	CSE	9347713052	Keerthana
57	P. Indu	CSE	7780209474	P. Indu
58	P. Bhagyalakshmi	CSE	7671881655	P. Bai
59	K. Amrutha	CSE	9912289593	K. Amrutha
60	k. kalyan	CSE	9989236228	kalyan
61	k. vema krishna	CSE	6302640320	vema
62	k. Rajesh	CSE	7013952188	k. Rajesh
63	K. Sai	CSE	984960321	Sai

Coordinator

HOD/H&S

V. S. S. MMLK
Principal
PRINCIPAL

Dr. I. SREEVANI M.Sc., Ph.D.
Head of Humanities & Sciences
K.S.R.M. College of Engineering
KADAPA - 516 005

K.S.R.M. COLLEGE OF ENGINEERING
KADAPA-516003. (A.P.)



K.S.R.M. COLLEGE OF ENGINEERING (UGC-AUTONOMOUS)

Kadapa, Andhra Pradesh, India- 516 003

Approved by AICTE, New Delhi & Affiliated to JNTUA, Ananthapuramu.

An ISO 14001:2004 & 9001: 2015 Certified Institution

Activity Report

Name of the Activity	Seminar on Power of Body Language	
Type of Activity	Student Centric Event	
Date and Time of Activity	31-10-2019	03:00 pm to 5:00 pm
Details of Participants	Students (63)	
Coordinator(s)	Sri. A. Anand Rao, Asst. prof, Dept. of H&S	
Organizing Dept./Support System	Department of Humanities and Sciences	
Description	<p>One day seminar on “The Power of Body Language” has been organized by the Department of Humanities & Sciences on 31st October, 2019 in Civil Seminar Hall at 3.00 pm. The main aim of the seminar is “to talk about a very important and powerful topic – body language, which plays a key role in the recruitment process of each and every organization out there”. Students actively participated in seminar. The presentation given by the resource person K. Eswara Reddy on introduction of the body language and its types made students to be in seminar with more interest and enthusiasm. Some of the students interacted with the speaker and cleared their doubts. Finally, the program was concluded with the vote of thanks by Mr. N. Raghunatha Reddy, Asst. Professor, Dept. of H&S. Around 63 students actively participated in the program.</p>	

Photos



Coordinator A. Anand Rao, addressing the students



Compute Science and Civil Engineering, KSRM Hostel Rd, Andhra Pradesh 516003, India

Latitude 14.476915° Longitude 78.765082°

LOCAL 03:25:56 GMT 08:55:56 THURSDAY 31.10.2019 ALTITUDE 50 METER

Speaker Sri. K. Eswara Reddy explaining importance of body language to the students

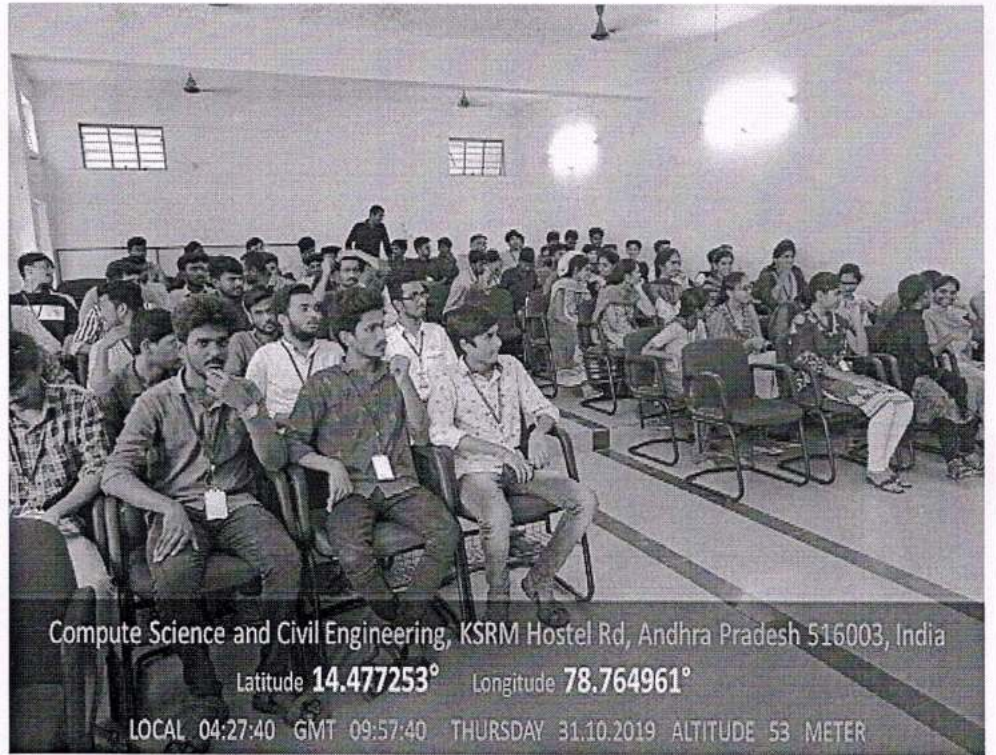

Compute Science and Civil Engineering, KSRM Hostel Rd, Andhra Pradesh 516003, India

Latitude **14.477253°** Longitude **78.764961°**

LOCAL 04:27:40 GMT 09:57:40 THURSDAY 31.10.2019 ALTITUDE 53 METER

students listening to speaker

Coordinator

HOD
Dr. I. SREEVANI M.Sc., Ph.D.
Head of Humanities & Science
K.S.R.M. College of Engineering
KADAPA - 516 005



K.S.R.M COLLEGE OF ENGINEERING, KADAPA

(Autonomous)

Yerramasupalli, Kadapa, Andhra Pradesh – 516003

Department of Humanities & Sciences

Feedback Form

On

“Power of Body Language”

30-10-2019

1. The Session has increased my knowledge in the given topic
 Strongly agree Agree Disagree Strongly Disagree

2. Did you find the seminar useful & Interactive
 Yes No

3. The lecture was clear and understanding
 Strongly agree Agree Disagree Strongly Disagree

4. Did you find the speaker interactive during the session
 Strongly agree Agree Disagree Strongly Disagree

5. What is the overall experience of the seminar
 Excellent Good Neutral Not good

Suggestions if any:

Signature of the participant



K.S.R.M COLLEGE OF ENGINEERING, KADAPA

(Autonomous)

Yerramasupalli, Kadapa, Andhra Pradesh – 516003

Department of Humanities & Sciences

Feedback Form

On

“Power of Body Language”

30-10-2019

1. The Session has increased my knowledge in the given topic
[] Strongly agree [] Agree [] Disagree [] Strongly Disagree

2. Did you find the seminar useful & Interactive
[] Yes [] No

3. The lecture was clear and understanding
[] Strongly agree [] Agree [] Disagree [] Strongly Disagree

4. Did you find the speaker interactive during the session
[] Strongly agree [] Agree [] Disagree [] Strongly Disagree

5. What is the overall experience of the seminar
[] Excellent [] Good [] Neutral [] Not good

Suggestions if any:

K. Sai
Signature of the participant



K.S.R.M COLLEGE OF ENGINEERING, KADAPA

(Autonomous)

Yerramasupalli, Kadapa, Andhra Pradesh – 516003

Department of Humanities & Sciences

Feedback Form

On

“Power of Body Language”

30-10-2019

1. The Session has increased my knowledge in the given topic
 Strongly agree Agree Disagree Strongly Disagree

2. Did you find the seminar useful & Interactive
 Yes No

3. The lecture was clear and understanding
 Strongly agree Agree Disagree Strongly Disagree

4. Did you find the speaker interactive during the session
 Strongly agree Agree Disagree Strongly Disagree

5. What is the overall experience of the seminar
 Excellent Good Neutral Not good

Suggestions if any:

C. Bhargavi
Signature of the participant



K.S.R.M COLLEGE OF ENGINEERING, KADAPA

(Autonomous)

Yerramasupalli, Kadapa, Andhra Pradesh – 516003

Department of Humanities & Sciences

Feedback Form

On

“Power of Body Language”

30-10-2019

1. The Session has increased my knowledge in the given topic
[] Strongly agree [] Agree [] Disagree [] Strongly Disagree
2. Did you find the seminar useful & Interactive
[] Yes [] No
3. The lecture was clear and understanding
[] Strongly agree [] Agree [] Disagree [] Strongly Disagree
4. Did you find the speaker interactive during the session
[] Strongly agree [] Agree [] Disagree [] Strongly Disagree
5. What is the overall experience of the seminar
[] Excellent [] Good [] Neutral [] Not good

Suggestions if any:

Kallejan
Signature of the participant



K.S.R.M COLLEGE OF ENGINEERING, KADAPA

(Autonomous)

Yerramasupalli, Kadapa, Andhra Pradesh – 516003

Department of Humanities & Sciences

Feedback Form

On

“Power of Body Language”

30-10-2019

1. The Session has increased my knowledge in the given topic
 Strongly agree Agree Disagree Strongly Disagree

2. Did you find the seminar useful & Interactive
 Yes No

3. The lecture was clear and understanding
 Strongly agree Agree Disagree Strongly Disagree

4. Did you find the speaker interactive during the session
 Strongly agree Agree Disagree Strongly Disagree

5. What is the overall experience of the seminar
 Excellent Good Neutral Not good

Suggestions if any:

Kishore

Signature of the participant



K.S.R.M. COLLEGE OF ENGINEERING
(UGC-AUTONOMOUS)

Kadapa, Andhra Pradesh, India- 516 003

Approved by AICTE, New Delhi & Affiliated to JNTUA, Ananthapuramu.

An ISO 14001:2004 & 9001: 2015 Certified Institution

Lr./KSRMCE/ (ECE)/2018-19/

Date: 11-09-2018

To
The Principal,
K.S.R.M. College of Engineering
Kadapa.

Respected Sir,

Sub: KSRMCE – ECE – “Seminar on “Wireless communication networks” – Requested -
Reg.

The ECE department is going to organize a “Seminar on “Wireless communication networks” on 14-09-2018. In this regard I kindly request you to permit us, to organize the same.

Thanking you sir,

*Forwarded to the
Principal Sir
G.H.M.*

*Permitted
U.S.S. Murthy
11/09/2018*

K. Pavan
Your's Faithfully

Sri. S. Pavan Kumar

Asst. Professor, ECE



K.S.R.M. COLLEGE OF ENGINEERING (UGC-AUTONOMOUS)

Kadapa, Andhra Pradesh, India- 516 003

Approved by AICTE, New Delhi & Affiliated to JNTUA, Ananthapuramu.
An ISO 14001:2004 & 9001: 2015 Certified Institution

Cr./KSRMCE/ (Department of E.C.E)/2018-19/

Date: 12-09-2018

Circular

It is hereby informed that A Seminar on “Wireless communication networks” is going to be organized by department of E.C.E on 14th September, 2018 from 10:00AM -12:00 PM

In this connection, all the ECE students and faculty are hereby directed to attend the seminar without fail.

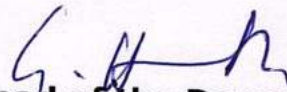
Head of the Department

Professor & H.O.D.
Department of E.C.E.
K.S.R.M. College of Engineering
KADAPA - 516 003

Cc:

IQAC

KSRMCE



K.S.R.M. COLLEGE OF ENGINEERING

(Autonomous)

Kadapa, Andhra Pradesh, India- 516 003

Approved by AICTE, New Delhi & Affiliated to JNTUA, Ananthapuramu.

Department of ECE

Seminar on WIRELESS COMMUNICATION NETWORKS

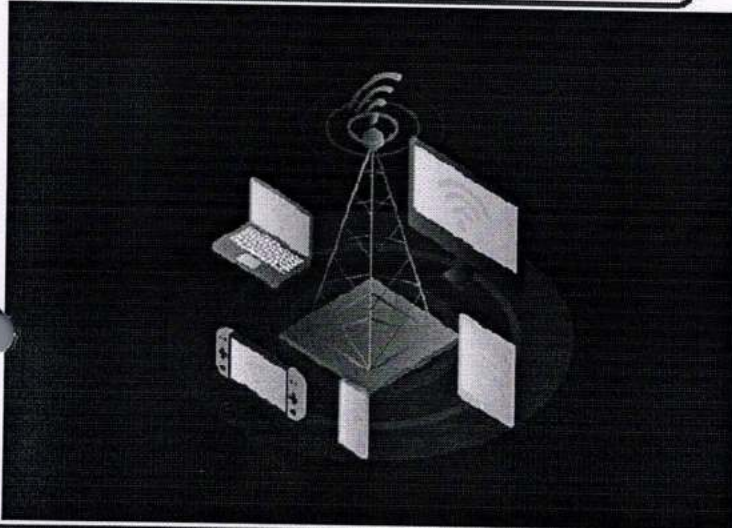

Resource person

SRI. S.L. PRATHAPA REDDY

Asst.Professor, ECE, KORMCE

Coordinator

Sri. K.Pavankumar
Assistant Professor, ECE

Date

14-09-2018

Venue

SJ Seminar Hall

Sri K. Chandra Obul Reddy
Management Member,
M.D of K.D.R. Ginning & Oil Mills Pvt. Ltd.

Sri K. Madan Mohan Reddy
Vice-Chairman

Sri K. Sivananda Reddy
Correspondent

Sri S. Sankar Reddy
Chairman

Prof. A. Mohan
Director

Prof. V.S.S. Murthy
Principal

Dr. G. Hemalatha
Professor, HOD, ECE
Convener



K.S.R.M. COLLEGE OF ENGINEERING

(AUTONOMOUS)

Kadapa, Andhra Pradesh, India- 516 003

Approved by AICTE, New Delhi & Affiliated to JNTUA, Ananthapuramu.

An ISO 14001:2004 & 9001: 2015 Certified Institution

ACTIVITY REPORT

Seminar on

“Wireless communication networks”

14th September, 2018

10:00 AM -12:00 Noon

Target Group	:	Students
Details of Participants	:	78 Students
Resource person	:	Sri. S.L.Prathapareddy, Asst.Professor, ECE
Coordinators	:	K. Pavan Kumar, Asst.Professor, ECE Dept.
Organizing Department	:	Electronics and Communication Engineering
Venue	:	SJ Seminar hall

Description:

The Guest Sri. S.L. Prathapa Reddy explained the concepts Wireless communication networks. The methodologies and the areas where to use these methodologies. The Present scenario of Wireless communication networks. He explained every concept by taking understandable examples.

The lecture started with the essence of the requirement of modulation. The speaker has stressed upon the requirement of data, signals and which in turn perceived as information are sent from one location to another in fraction of seconds in the current day. This is possible with the rapid development in the field of Electronics and Communication Engineering. Earlier systems use analog modulation that allows the message signal to be propagated over longer distances. But these systems tend to be vulnerable to noise. Hence, with the developments in field of communications the new era of Digital conversion from Analog has evolved. Further, drawback on analog based communication systems are discussed paving way to digital communications. The speaker has stressed upon the usage and need for satellite communications. A communications satellite is an artificial satellite that relays and amplifies radio telecommunication signals via a transponder; it creates a communication channel between a source transmitter and a receiver at different locations on Earth. Communications satellites are used for television, telephone, radio, internet, and military applications. Further, the effect of environment on the satellite communications is discussed. The concepts of Non-LOS(NLOS) and beyond-LOS(BLOS) are the main highlights of the lecture that has motivated the entire stream of audience. These are the two main cases of propagation that are successfully deployed to provide robust and secure link. Further, highlighting on the requirement of wireless communications, the lecture ended with the introduction to the basics of cellular communications and a questionnaire from the students is dealt at the last.

Photos:

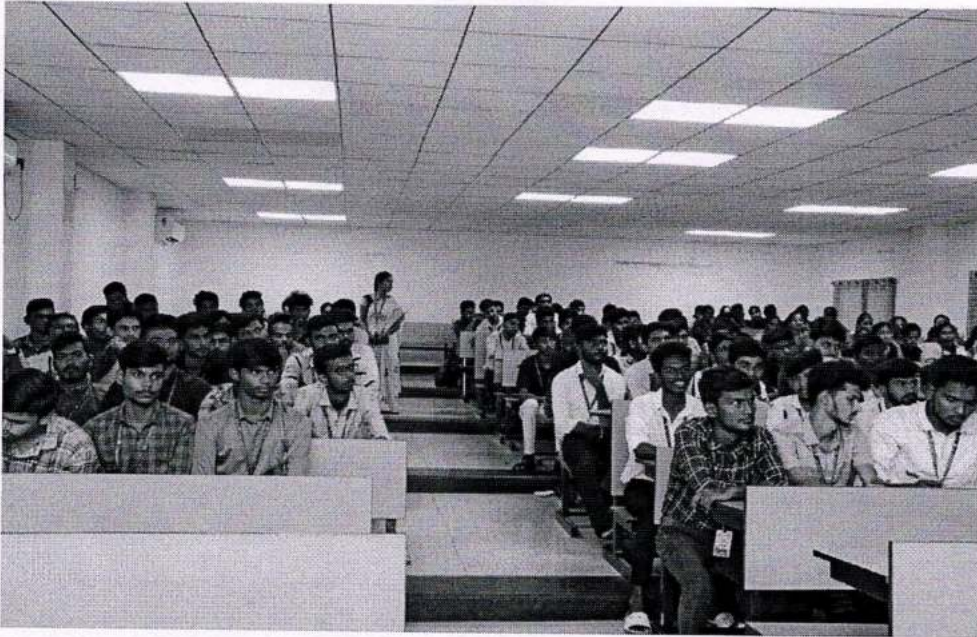

Fig (a): Faculty monitoring the students

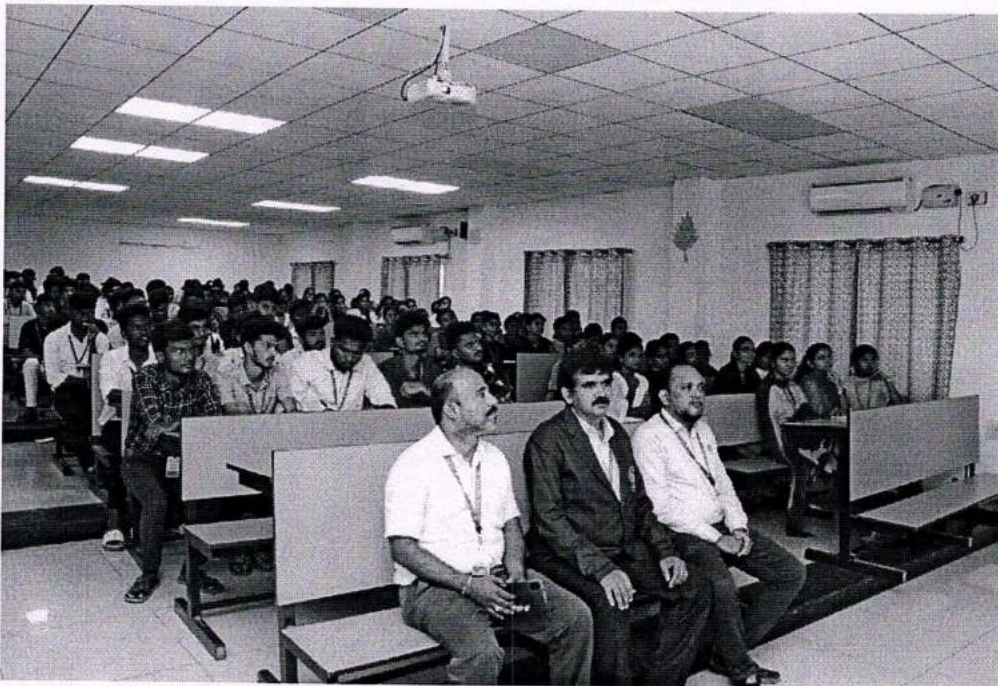

Fig (b): Students listening to the presentation.

K. Par
Coordinator

G. H. M.
HOD
Professor & H.O.D.
Department of E.C.E.
K.S.R.M. College of Engineering
KADAPA - 518 003

K.S.R.M. COLLEGE OF ENGINEERING

(UGC-AUTONOMOUS)

Kadapa, Andhra Pradesh, India- 516 003

Approved by AICTE, New Delhi & Affiliated to JNTUA, Ananthapuramu.

An ISO 14001:2004 & 9001: 2015 Certified Institution



Date: 14-09-2018

Name of the Event: Seminar on "Wireless communication networks"

Venue: SJ Seminar hall

List of Participants

S. No	Roll No	Name	Email Id	Signature
1	169Y1A0469	N. Harika	nandivadaharika@gmail.com	Harika
2	169Y1A0470	N. Saikrishna	nsaikrishna390@gmail.com	Saiki
3	169Y1A0471	O. Chaitanya Ravi	obulreddychaitanya@gmail.com	Chaitanya
4	169Y1A0472	O. Padmaja	orbenddupadma@gmail.com	Padma
5	169Y1A0473	P. Sreenivasulureddy	reddysreenivasulureddy@gmail.com	P. Sreenivasulureddy
6	169Y1A0474	P. Sadathullah	shahidsadathullah13@gmail.com	Sadathullah
7	169Y1A0475	P. Snevani	Pankajasthani@gmail.com	Snevani
8	169Y1A0476	P. Jasikummar	Jasikummar07@gmail.com	P. Jasikummar
9	169Y1A0477	P. Priyanka Choudhary	Priyanka234@gmail.com	Priyanka
10	169Y1A0478	P. Maheshwari Riddhi	maheshwari09@gmail.com	Maheshwari
11	169Y1A0479	P. Sreevani	Sreevani81999@gmail.com	Sreevani
12	169Y1A0480	P. Mona	mona@gmail.com	P. Mona
13	169Y1A0481	P. Venkata Krishna	Pvenkatakrishna63@gmail.com	Venkata Krishna
14	169Y1A0482	P. Sai Prasad	Prasadgoud533@gmail.com	Sai Prasad
15	169Y1A0482	P. Madhusudan	ibnmadhusudan@gmail.com	Madhusudan
16	169Y1A0482	P. Sai Prasad	Prasadgoud533@gmail.com	Sai Prasad
17	169Y1A0484	P. Manish	champion.c221@gmail.com	Manish
18	169Y1A0486	R. Yashanth Reddy	Yreddy72@gmail.com	Yashanth Reddy
19	169Y1A0487	S. Sravani	Sella Sravani@gmail.com	Sravani
20	169Y1A0488	Pavanireddy	Pavanireddy@gmail.com	Pavanireddy
21	169Y1A0489	S. Anun Kumar	ibm145149363@gmail.com	Anun Kumar

1 Reddy

22	16941A0490	S. Kshema	saparana98@gmail.com	Kshema
23	16941A0491	S. Afra Arsheen	afraarsheen99@gmail.com	Afra Arsheen
24	16941A0492	S. Mahabub Saif	asifpandy204@gmail.com	Mahub
25	16941A0493	S. P. Madhusudan	madhusudhanreddy@gmail.com	Madhu
26	16941A0480	P. MONA	Pishamona@gmail.com	mona
27	16941A0431	G. Manisha	gallamaniSha@gmail.com	manisha
28	16941A0426	D. Deepa	davanamdeepa@gmail.com	Deepa
29	16941A0401	A. Ramkumar	ram.agnikondu@gmail.com	Ramkumar
30	16941A0499	G. Rachana	g.rachana@gmail.com	Rachana
31	16941A0421	C. Sudharshan	csudharshan@gmail.com	C. Sun
32	16941A0414	B. Reddy Sushma	sushmabayapureddy@gmail.com	B. Sushma
33	16941A0411	B. Suresh	barinela.suresh@gmail.com	B. Suresh
34	16941A0441	T. Nagaraj Prasad	knagarajprasad@gmail.com	T. Nagaraj Prasad
35	16941A0442	U. Akber Saleem	akbersaleem909@gmail.com	U. Akber
36	16941A0401	A. Ramkumar	ram.agnikondu@gmail.com	A. Ramkumar
37	16941A0402	A. Chanda Priya	akishettychandapriya@gmail.com	A. Chanda Priya
38	16941A0403	A. Gunasakritha	sukrishnareddy@gmail.com	A. Gunasakritha
39	16941A0404	A. Anapurna Reddy Kalani	mail2kalvan@gmail.com	Kalani
40	16941A0405	A. Sai Sumitha	saisumitha@gmail.com	Sai Sumitha
41	16941A0406	A. Mahamad Ahsad	ahshah1000@gmail.com	A. Mahamad Ahsad
42	16941A0407	A. Ganesha Natesh	athitoo@gmail.com	A. Ganesha Natesh
43	16941A0408	K. AYESH A	ahmed-sultan@gmail.com	K. AYESH A
44	16941A0409	B. Sivateja Reddy	sivatejareddy@gmail.com	B. Sivateja Reddy
45	16941A0410	B. Uday Kumar	udaywick@gmail.com	Uday
46	16941A0411	B. ARINELA Suresh	barinela.suresh@gmail.com	Arinela
47	16941A0412	B. Raja Serhan	basireddy.raja.serhan@gmail.com	Raja Serhan
48	16941A0413	B. Chandanapriya	uswathapriya@gmail.com	B. Chandanapriya
49	16941A0414	B. Reddy Sushma	sushmabayapureddy@gmail.com	B. Sushma
49	16941A0415	B. Navya Sree	navya.sareebomireddy99@gmail.com	Navya Sree
50	16941A0416	C. Poudhvi Raju	poudhvi.raj@gmail.com	Raju
51	16941A0417	C. Sashitha	sashitha@gmail.com	Sashitha

52	16941A0418	C. Sai Sandeep Reddy	c.sai.sandeep104@gmail.com	Sai
53	16941A0421	C. Sudarshana	choudhary.sudarshana@gmail.com	Sa
54	16941A0422	C. Raja ^{Naga Raja Sakha}	cnr.sk@gmail.com	Narasimha Sakha
55	16941A0423	D. Vishnu	vishnuinPb626@gmail.com	Vishnu
56	16941A0424	D. Aravind	aravind@gmail.com	Aravind
57	16941A0425	D. Bhaskar	bhaskar767202675	Baskar
58	16941A0426	Do Deepa	dovanandeepta@gmail.com	deepa
59	16941A0427	E. Rajasekhara ^{reddy}	raja.ravi0806@gmail.com	Raja Ravi
60	16941A0428	E. Siva Reddy	eragamisivarreddy222	Siva Reddy
61	16941A0429	G. Rachana	g.rachana@gmail.com	Rachana
62	16941A0430	G. Deepthi	g.deepthi@gmail.com	Deepthi
63	16941A0431	G. Manisha	galla.manisha@gmail.com	Manisha
64	16941A0432	G. Anil Kumar	anil.kumar@gmail.com	Anil Kumar
65	16941A0439	K. Sai Teja	ksait@gmail.com	Sai Teja
66	16941A0458	M. RAMIREDDY	MPanireddy422@gmail.com	Ramireddy
67	16941A0465	M. Ramasunil	MPamosunil@gmail.com	Ramasunil
68	16941A0439	J. Pallavi	Jangdipallavi@gmail.com	Pallavi
69	16941A0456	M. Radha	Radha.maddusi99@gmail.com	Radha
70	16941A0463	M. Manika	ManikaReddy@gmail.com	Manika
71	16941A0454	M. Manoj Kumar	mechmanojkumar@gmail.com	Manoj
72	16941A0416	K.V. Mallikarjun	mallikarjuna@gmail.com	Mallikarjun
73	16941A0448	K. Chandramouli	kchondramouli@gmail.com	Chandramouli
74	16941A0457	M. Adhishesh Reddy	adhiseshreddy@gmail.com	Adhishesh
75	16941A0442	K. Harini Prasad	harini.prasad.gandhi@gmail.com	Harini
76	16941A0468	N. Amreshwar	amreshwar92@gmail.com	Amreshwar
77	16941A0443	K. Sunalatha	sunalatha@gmail.com	Sunalatha
78	16941A0437	G. Vinitha	gvinitha@gmail.com	Vinitha

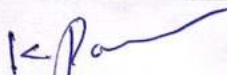
Co-ordinator

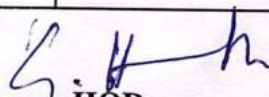
HOD
Professor & H.O.D.
Department of E.C.E.
K.S.R.M. College of Engineering
KADAPA - 516 003



K.S.R.M. COLLEGE OF ENGINEERING

(AUTONOMOUS)

Kadapa, Andhra Pradesh, India- 516 003

Approved by AICTE, New Delhi & Affiliated to JNTUA,
Annanthapuramu.

An ISO 14001:2004 & 9001: 2015 Certified Institution

Lr/KSRMCE/DEPARTMENT OF ME /2018-2019 /

Date: 14/03/2019

To
The PRINCIPAL
KSRM College of Engineering
KADAPA.

Sub: KSRMCE – Dept. of ME- Permission for a One Week Workshop on IPR”-Request-Reg.

---***---

//THROUGH PROPER CHANNEL//

Respected Sir,

It is brought to your kind notice that, Department of Mechanical Engineering is planning to organize a One Week Workshop on IPR from 17th to 21st Dec 2018. The speakers are Dr. S.Shakeel Ahamad, Professor & HOD, AITS, KADAPA, Dr. D. Krishna Mohan Raju, Prof & Dean of Innovation center, AITS, RAJAMPETA. In this regard I request you to give permission and financial assistance to meet the needs and for smooth completion of the program.

Thanking you sir,

Yours faithfully

C.Nagaraja
(Coordinator)

Assistant Professor in MED

Forwarded to Principal Sir
D. S. S. M. M. / 14

Permitted
D. S. S. M. M. / 14



K.S.R.M. COLLEGE OF ENGINEERING (UGC-AUTONOMOUS)

Kadapa, Andhra Pradesh, India- 516 003

Approved by AICTE, New Delhi & Affiliated to JNTUA, Ananthapuramu.

An ISO 14001:2004 & 9001: 2015 Certified Institution

Lr/KSRMCE/DEPARTMENT OF ME /2018-2019 /

Date: 21/03/2019

Circular

It is immense pleasure to inform that the Department of Mechanical Engineering conducting “a one-week workshop on IPR” from 25th to 29th March-2019. In this regard, interested faculty members and students are requested to register for the workshop. For the registration, please contact C.Nagaraja coordinator of the workshop.

HOD

Professor & head
Department of Mechanical Engineering
K.S.R.M. College of Engineering
KADAPA - 516 003.

CC to :

The HOD, Department of Mechanical, K.S.R.M.C.E

IQAC, K.S.R.M.C.E

Final year students

Coordinator



K.S.R.M. COLLEGE OF ENGINEERING

(AUTONOMOUS)

Kadapa, Andhra Pradesh, India- 516 003

Approved by AICTE, New Delhi & Affiliated to JNTUA,
Ananthapuramu.

An ISO 14001:2004 & 9001: 2015 Certified Institution

ACTIVITY REPORT

Name of the Activity	A One Week Workshop on Intellectual Property Rights	
Type of Activity	A One Week Workshop	
Date and Time of Activity	25/03/2019 to 29/03/2019	10:00 AM TO 4 :00 PM
No. of Participants	62	
Resource Persons	Dr. S. Shakeel Ahamad, Professor & HOD, AITS, KADAPA, Dr. D. Krishna Mohan Raju, Prof & Dean of Innovation center, AITS, RAJAMPETA.	
Coordinator	C.Nagaraja, Asst.Professor	
Organizing Department	Mechanical Engineering	
Plat Form	OFF-LINE	
Venue	Mechanical Engineering Graphics Lab	
Description	<p>Program Inaugurated by Dr. V.V. Sreenivasa Murty, Principal ,Dr.D.Ravikanth, Prof & Hod and C.Nagaraja, coordinator and followed by welcome speech and lighting of Lamp. Resource persons of five-day workshop presented their speech on IPR and its importance. Five Days workshop covers following important points elaborately</p> <ul style="list-style-type: none">• Intellectual Property Rights?• History of IPR?• Copy rights?• Patents ?• How to File Patents?• Trademarks?• Trade Secrets?• Opposition Proceedings? <p>The Five Days Program Ended with oath of thanks to Management Members, Principal, Director, HOD, and Participants for their Encouragement and Support, Feedback from Participants has Collected at end of sessions for all five Days and Certificates are Distributed to Participants.</p>	

Welcome to one week workshop on
Intellectual property rights
25/03/2019 To 29/03/2019

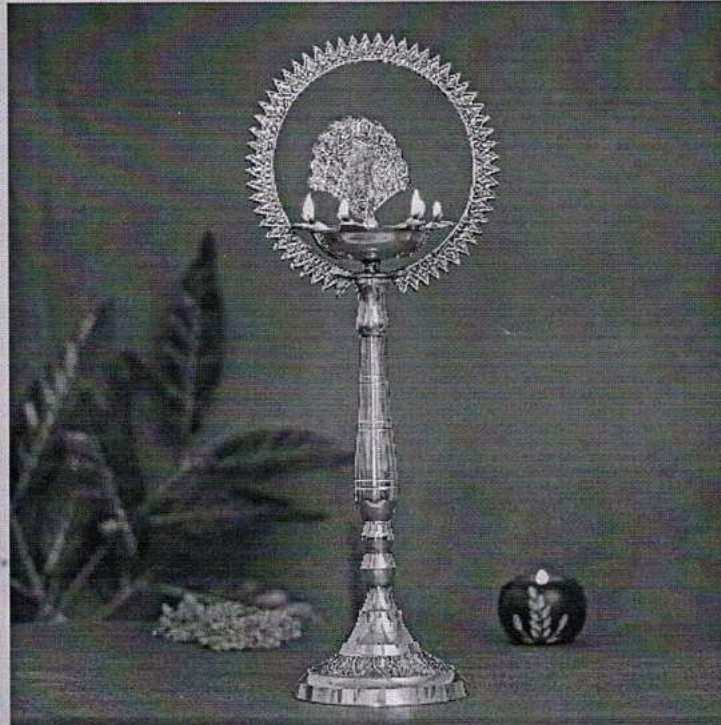

**DEPARTMENT OF MECHANICAL
ENGINEERING
K.S.R.M COLLEGE OF ENGINEERING
KADAPA**

 /kasmce.ac.in

Follow Us:



/kasmceofficial

Day 1

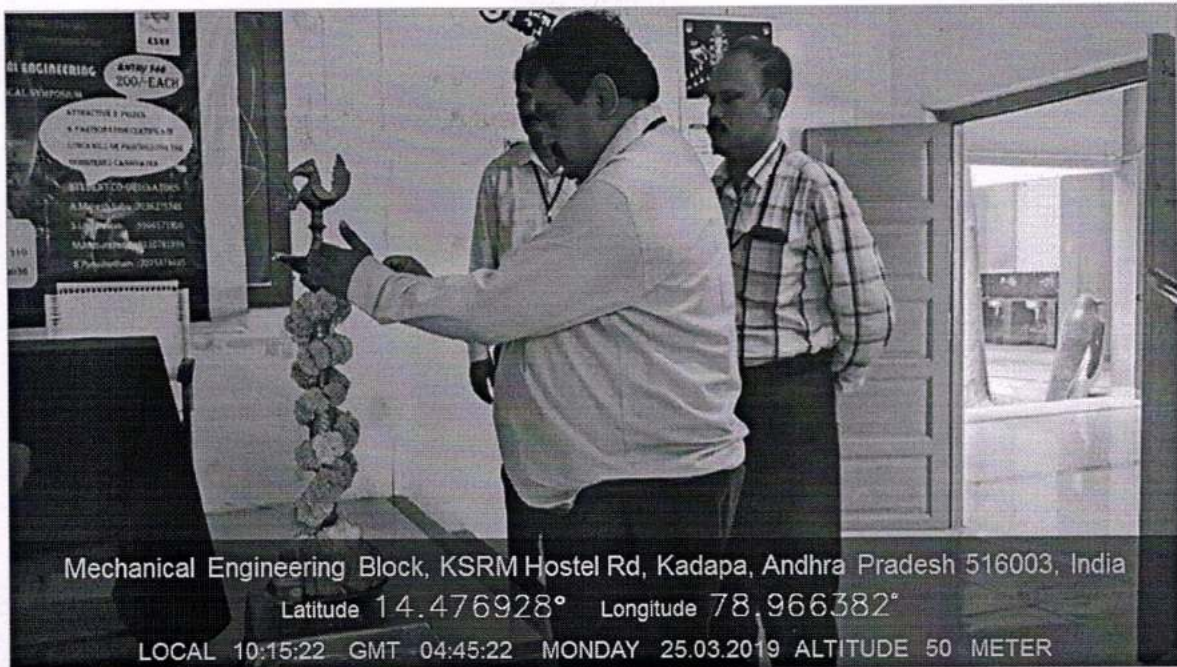

Lightening the lamp in Inauguration function by Dr.D.Ravikanth Professor & HOD and Dr. S. Shakeel Ahmad, Professor & HOD, AITS, KADAPA

What is meant by IPRs?



Intellectual Property (IP) is any creations of human mind. Like tangible property, their creation has a value and, as with all property, it needs to be protected.

Intellectual Property Rights (IPR) gives them this protection, as well as helping them exploit and control their IP.

“The exclusive right granted by State, to prevent others from using, manufacturing, distributing - inventions, processes, applications, new and original designs, trademarks, new plant varieties, data bases and artistic and literary works”. Such a person is known as ‘rights owner’ or ‘rights holder’.



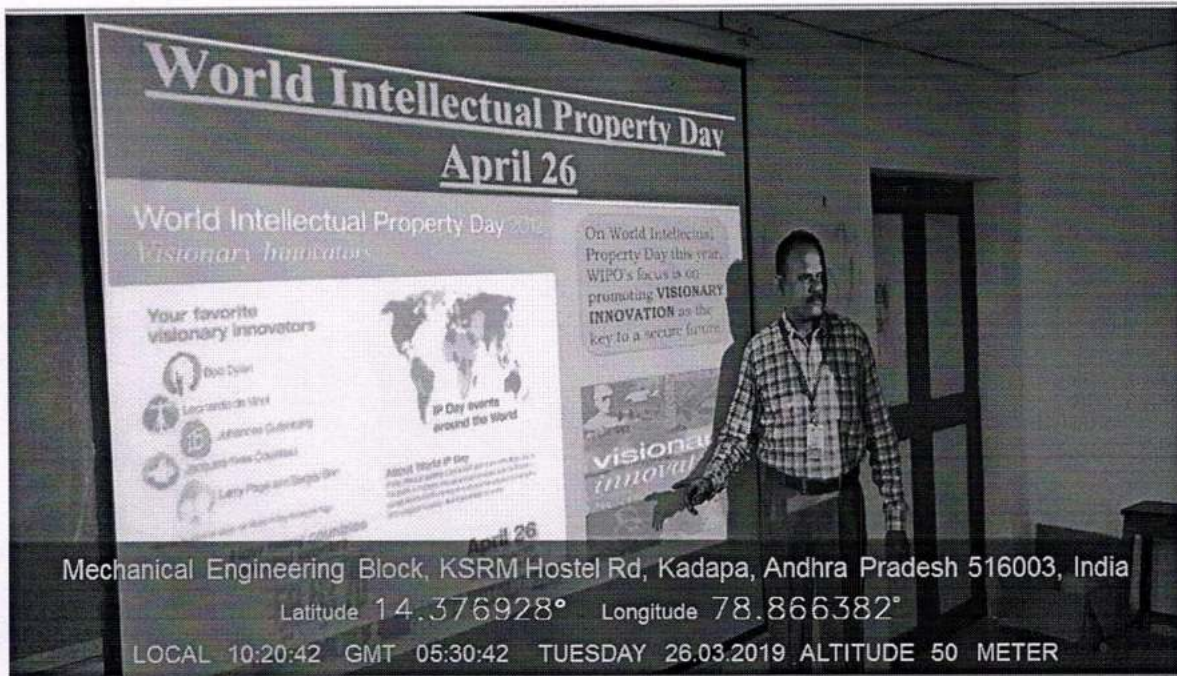

Dr. S. Shakeel Ahmad, Professor & HOD, AITS, KADAPA has delivered his valuable speech on Introduction to IPR and copy rights

Types of IPRs Intellectual Property

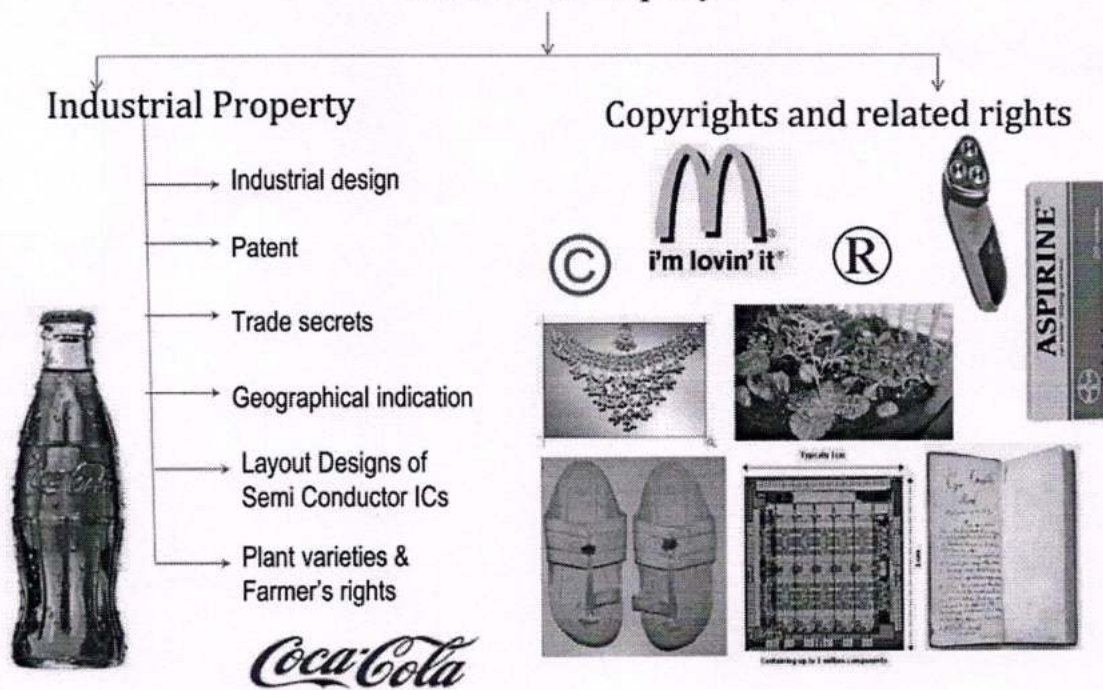

The resource person presenting various types of IPRs

Day 3

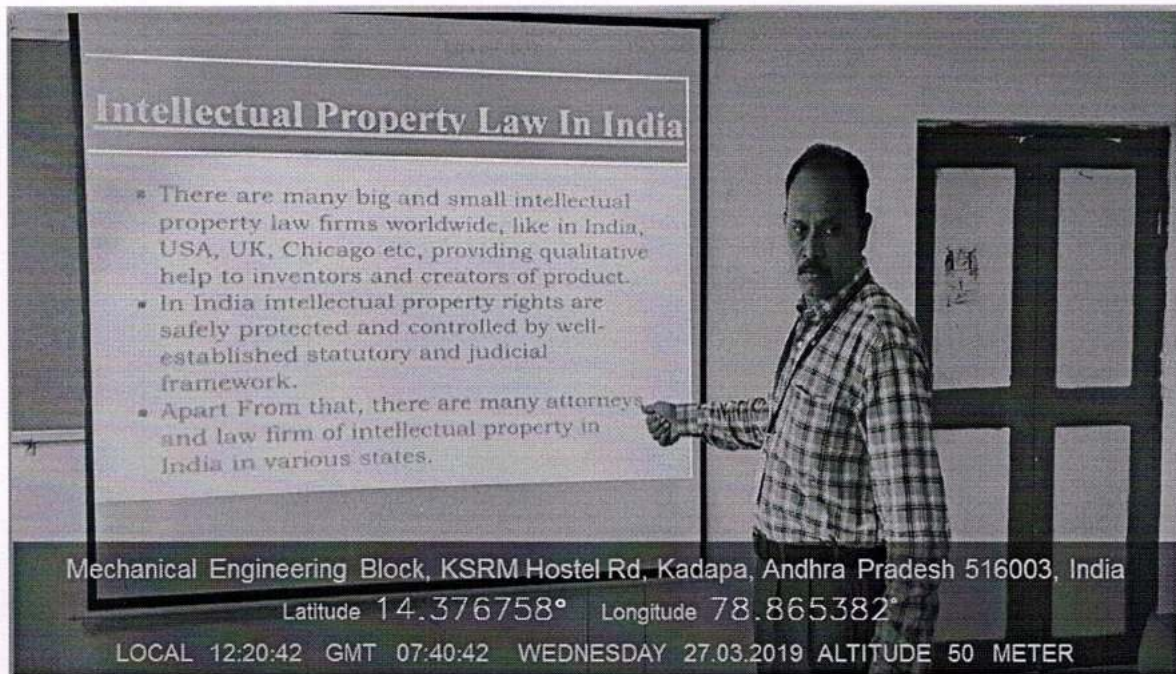

Dr. S. Shakeel Ahmad, Professor & HOD, AITS, KADAPA has delivered his valuable speech on intellectual property law in India

IP RIGHTS

REGISTERED

- Patents
- Trade Marks
- Design rights

UNREGISTERED

- Copyright
- Unregistered Design rights
- Common law trade marks
- Database rights
- protection for know how under laws dealing with confidential information and trade secrets
- Plant varieties
- Geographical Indications
- Design of Integrated Circuits
- 'Passing off' trade legislation (Domain names)

Dr. S. Shakeel Ahmad, Professor & HOD, AITS, KADAPA has delivered his valuable speech on IP RIGHTS



/kasmce.ac.in

Follow Us:



/kasmceofficial

Day 4



Dr. D. Krishna Mohan Raju, Prof & Dean of Innovation center, AITS, RAJAMPETA is resource person on day 4 and discussed how to apply for patent, Trade secrets and other key related issues in IPR

What are Patent Rights

- To prevent third party without authorization
- Making or manufacturing
- Using
- Offering for sale
- Selling
- Importing
- Distributing
- Licensing

Dr. D. Krishna Mohan Raju, Prof & Dean of Innovation center, AITS, RAJAMPETA has delivered his valuable speech on what are the patent rights

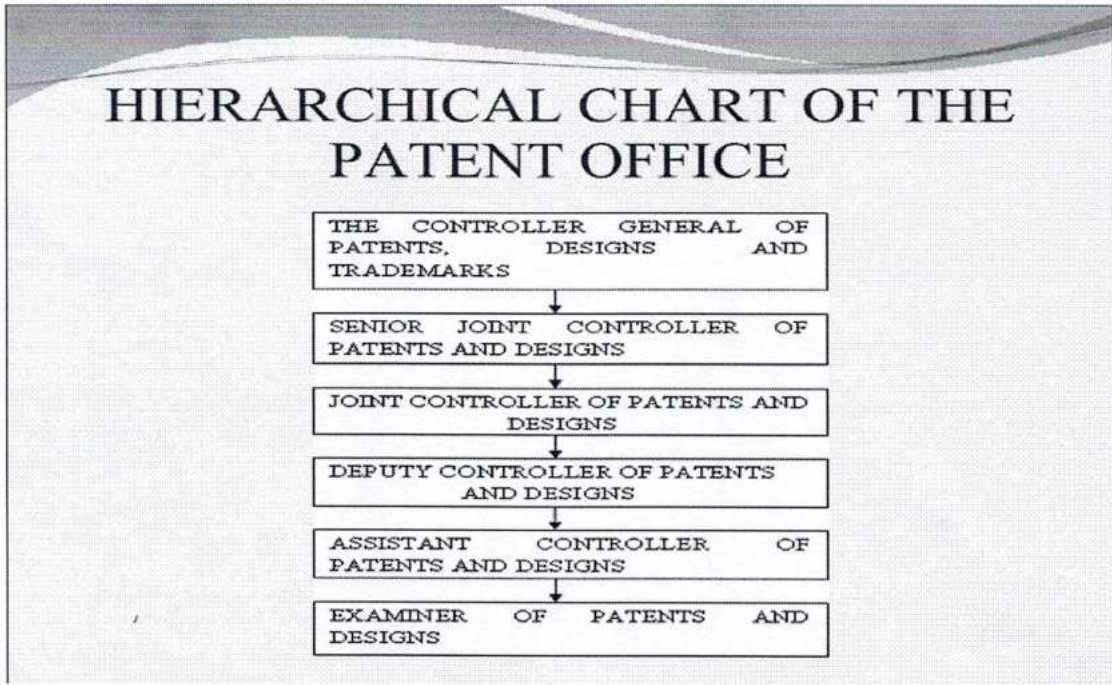

Dr. D. Krishna Mohan Raju, Prof & Dean of Innovation center, AITS, RAJAMPETA discussed about Hierarchical chart of the patent office



Mechanical Engineering Block, KSRM Hostel Rd, Kadapa, Andhra Pradesh 516003, India
Latitude 14.376755° Longitude 78.865362°
LOCAL 15:21:42 GMT 10:41:42 FRIDAY 29.03.2019 ALTITUDE 50 METER

Dr.D.Ravikanth Professor & HOD distributing the certificates to the participants

COORDINATOR

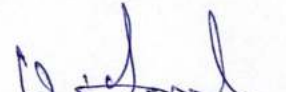
HOD

Professor & head
Department of Mechanical Engineering
K.S.R.M. College of Engineering
KADAPA- 516 003.

 /ksrmce.ac.in

Follow Us:



/ksrmceofficial



K.S.R.M. COLLEGE OF ENGINEERING

(UGC-AUTONOMOUS)

Kadapa, Andhra Pradesh, India- 516 003

Approved by AICTE, New Delhi & Affiliated to JNTUA, Ananthapuramu.

An ISO 14001:2004 & 9001: 2015 Certified Institution

22	169Y1A0328	Mandadi V L N S Karthikeya Sharma	v.l.n.s.k.s	v.l.n.s.k.s	v.l.n.s.k.s	v.l.n.s.k.s	v.l.n.s.k.s
23	169Y1A0329	Mandli Trilokanath	M. Trilokanath	M. Trilokanath	M. Trilokanath	M. Trilokanath	M. Trilokanath
24	169Y1A0343	Peddammaddolla Sanmukhanath	P. Sanmukhanath	P. Sanmukhanath	P. Sanmukhanath	P. Sanmukhanath	P. Sanmukhanath
25	169Y1A0344	Peddapaga Vijayakumar	P. Vijayakumar	P. Vijayakumar	P. Vijayakumar	P. Vijayakumar	P. Vijayakumar
26	169Y1A0345	Penugonda Venkatesh	P. Venkatesh	P. Venkatesh	P. Venkatesh	P. Venkatesh	P. Venkatesh
27	169Y1A0346	Penumala Vishnu Gopal	P. Vishnu Gopal	P. Vishnu Gopal	P. Vishnu Gopal	P. Vishnu Gopal	P. Vishnu Gopal
28	169Y1A0348	Rachakunta Hari Krishna	Hari Krishna	Hari Krishna	Hari Krishna	Hari Krishna	Hari Krishna
29	169Y1A0349	Rakesh Jonnagiri	R. Jonnagiri	R. Jonnagiri	R. Jonnagiri	R. Jonnagiri	R. Jonnagiri
30	169Y1A0350	Ramavath Rama Naik	R. Naik	R. Naik	R. Naik	R. Naik	R. Naik
31	169Y1A0351	Sabbasani Durga Mallikarjuna Reddy	S. Durga	S. Durga	S. Durga	S. Durga	S. Durga
32	169Y1A0362	Syed Mansoor	S. Mansoor	S. Mansoor	S. Mansoor	S. Mansoor	S. Mansoor
33	169Y1A0363	Syed Mohammed Nayeem	S. Mohammed Nayeem	S. Mohammed Nayeem	S. Mohammed Nayeem	S. Mohammed Nayeem	S. Mohammed Nayeem
34	169Y1A0365	Syed Usman Harooni	S. Harooni	S. Harooni	S. Harooni	S. Harooni	S. Harooni
35	169Y1A0367	Y Nitish Kumar Reddy	Y. Nitish Kumar Reddy	Y. Nitish Kumar Reddy	Y. Nitish Kumar Reddy	Y. Nitish Kumar Reddy	Y. Nitish Kumar Reddy
36	169Y1A0369	Yeddula Bramhananda Reddy	Y. Bramhananda Reddy	Y. Bramhananda Reddy	Y. Bramhananda Reddy	Y. Bramhananda Reddy	Y. Bramhananda Reddy
37	169Y1A0370	Yerrakondreddigari Yugandhar Reddy	Y. Yugandhar Reddy	Y. Yugandhar Reddy	Y. Yugandhar Reddy	Y. Yugandhar Reddy	Y. Yugandhar Reddy
38	179Y5A0301	Ambati Guru Nagendra	A. Nagendra	A. Nagendra	A. Nagendra	A. Nagendra	A. Nagendra
39	179Y5A0303	Bolligala Narasimha	B. Narasimha	B. Narasimha	B. Narasimha	B. Narasimha	B. Narasimha
40	179Y5A0304	Boya Anil Kumar	A. Kumar	A. Kumar	A. Kumar	A. Kumar	A. Kumar
41	179Y5A0306	Chennamreddy Mallareddy	M. Mallareddy	M. Mallareddy	M. Mallareddy	M. Mallareddy	M. Mallareddy
42	179Y5A0307	Chillumuru Venkata Subba Reddy	C. Venkata Subba Reddy	C. Venkata Subba Reddy	C. Venkata Subba Reddy	C. Venkata Subba Reddy	C. Venkata Subba Reddy
43	169Y1A0327	Malepati Sivaprasad Reddy	S. Sivaprasad Reddy	S. Sivaprasad Reddy	S. Sivaprasad Reddy	S. Sivaprasad Reddy	S. Sivaprasad Reddy
44	179Y5A0308	Dulam Akhileswar	D. Akhileswar	D. Akhileswar	D. Akhileswar	D. Akhileswar	D. Akhileswar
45	179Y5A0309	Edula Jagadeeswar Reddy	E. Jagadeeswar Reddy	E. Jagadeeswar Reddy	E. Jagadeeswar Reddy	E. Jagadeeswar Reddy	E. Jagadeeswar Reddy
46	179Y5A0311	Golla Veeresh	G. Veeresh	G. Veeresh	G. Veeresh	G. Veeresh	G. Veeresh
47	179Y5A0312	Gopidesi Venkataramanaiah	G. Venkataramanaiah	G. Venkataramanaiah	G. Venkataramanaiah	G. Venkataramanaiah	G. Venkataramanaiah
48	179Y5A0313	Gubilivandla Anil	G. Anil	G. Anil	G. Anil	G. Anil	G. Anil
49	179Y5A0314	Gudipati Giri	G. Giri	G. Giri	G. Giri	G. Giri	G. Giri



K.S.R.M. COLLEGE OF ENGINEERING

(UGC-AUTONOMOUS)

Kadapa, Andhra Pradesh, India- 516 003

Approved by AICTE, New Delhi & Affiliated to JNTUA, Ananthapuramu.

An ISO 14001:2004 & 9001: 2015 Certified Institution

50	179Y5A0315	Jaripati Devendra	J. Devendra	J. Devendra	J. Devendra	J. Devendra	J. Devendra
51	179Y5A0316	Kammari Ganesh	K. Ganesh	K. Ganesh	K. Ganesh	K. Ganesh	K. Ganesh
52	179Y5A0317	Kattameedi Kiran Kumar Reddy	K. Kiran Kumar	K. Kiran Kumar	K. Kiran Kumar	K. Kiran Kumar	K. Kiran Kumar
53	179Y5A0318	Kola Yaswanth Kumar	K. Yaswanth Kumar	K. Yaswanth Kumar	K. Yaswanth Kumar	K. Yaswanth Kumar	K. Yaswanth Kumar
54	179Y5A0319	Kummari Mahesh Kumar	K. Mahesh Kumar	K. Mahesh Kumar	K. Mahesh Kumar	K. Mahesh Kumar	K. Mahesh Kumar
55	179Y5A0321	Kuruva Sivachandrudu	K. Sivachandrudu	K. Sivachandrudu	K. Sivachandrudu	K. Sivachandrudu	K. Sivachandrudu
56	179Y5A0322	Maddu Varun	M. Varun	M. Varun	M. Varun	M. Varun	M. Varun
57	179Y5A0323	Mallem Hari Pranay	M. Hari	M. Hari	M. Hari	M. Hari	M. Hari
58	179Y5A0324	Mandla Vijaya Kumar	M. Vijaya	M. Vijaya	M. Vijaya	M. Vijaya	M. Vijaya
59	179Y5A0325	Mangali Nagaraju	M. Nagaraju	M. Nagaraju	M. Nagaraju	M. Nagaraju	M. Nagaraju
60	179Y5A0326	Marriboina Siva Sankar Yadav	M. Sankar Yadav	M. Sankar Yadav	M. Sankar Yadav	M. Sankar Yadav	M. Sankar Yadav
61	179Y5A0327	Muthukuru Satish Kumar	M. Satish Kumar	M. Satish Kumar	M. Satish Kumar	M. Satish Kumar	M. Satish Kumar
62	179Y5A0328	Nadendla Kullayappa	N. Kullayappa	N. Kullayappa	N. Kullayappa	N. Kullayappa	N. Kullayappa

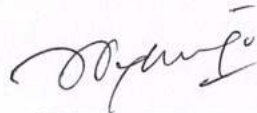
COORDINATOR

HOD



K.S.R.M. COLLEGE OF ENGINEERING

(UGC-AUTONOMOUS)

Kadapa, Andhra Pradesh, India- 516 003

Approved by AICTE, New Delhi & Affiliated to JNTUA, Ananthapuramu.

An ISO 14001:2004 & 9001: 2015 Certified Institution

Lr./KSRMCE/ (Humanities & Sciences)/2018-19

Date: 21.01.2019

To
The Principal,
K.S.R.M. College of Engineering
Kadapa.

From
K. Eswara Reddy,
Assistant Professor,
Department of H&S,
K.S.R.M College of Engineering
Kadapa.

Respected Sir,

Sub: KSRMCE - (Department of H&S) Permission to Conduct Awareness Program on Importance of Communication Skills on 24-01-2019 –Reg.

It is being brought to your kind notice that, with reference to the cited, the H&S Department is planning to **Conduct Awareness Program on Importance of Communication Skills on 24-01-2019 for I B. Tech students in Communicative English Lab.** In this regard I kindly request you sir to grant permission to organise this event. This is submitted for your kind perusal.

Thanking you Sir,

Yours faithfully

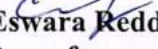
K. Eswara Reddy,
Asst. professor,
Dept. of H&S,
K.S.R.M.C.E.

*Forwarded to
Principal Sir
Dept. of H&S.*

*Permi Head
U. S. - S. M. M. / 5*



K.S.R.M. COLLEGE OF ENGINEERING

(UGC-AUTONOMOUS)

Kadapa, Andhra Pradesh, India- 516 003

Approved by AICTE, New Delhi & Affiliated to JNTUA, Ananthapuramu.

An ISO 14001:2004 & 9001: 2015 Certified Institution

Cr./KSRMCE/(Department of H&S)/2018-19

Date:22-01-2019

Circular

All the I B. Tech students are here by informed that Department of H&S is going to organize Awareness Program on Importance of Communication Skills on 24-01-2019 in Communicative English lab at 10.00 am. Interested students are instructed to attend the program without fail.

For any queries Contact,

Coordinator

K. Eswara Reddy,
Asst. Prof,
Dept. of H&S

HOD/H&S

Dr. I. SREEVANI M.Sc.,Ph.D
Head of Humanities & Sciences
K.S.R.M College of Engineering
KADAPA 516 003

Copy to all the HoD's for information and with a request to circulate among students.

Copy to the Director's Table.

Copy to the Office File.



K.S.R.M College of Engineering

(UGC-Autonomous)

Kadapa, Andhra Pradesh, India-516003

Approved by AICTE, New Delhi & Affiliated to JNTUA, Ananthapuramu

Department of Humanities & Sciences

Awareness Program on Importance of Communication Skills

Date of event: 24-01-2019

Time of event: 10.00 am

Venue: Communicative English Lab

Speaker

Sri. N. Bhaskara Reddy

Asst. Prof

Dept. of H&S

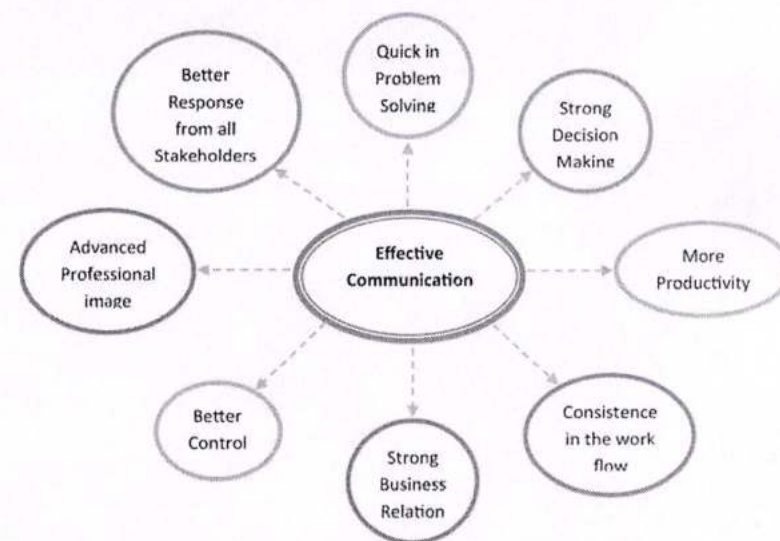

Sri. K. Eswara Reddy
Coordinator

Dr. I. Sreevani
Convener & HOD H&S

Dr. V. S. S. Murthy
Principal

Sri. K. Sivananda Reddy
Correspondent



K.S.R.M. COLLEGE OF ENGINEERING

(UGC-AUTONOMOUS)

Kadapa, Andhra Pradesh, India- 516 003

Approved by AICTE, New Delhi & Affiliated to JNTUA, Ananthapuramu.

An ISO 14001:2004 & 9001: 2015 Certified Institution

Date: 24-01-2019

Name of the Event: Awareness Program on Importance of Communication Skills

Venue : Communicative English lab

List of Participants

S. No	Name of the participant	Branch	Roll Number	Signature
1	A. Naveen Kumar	CE	189Y1A0102	A. Naveen Kumar
2	B. Maheswari	CE	189Y1A0108	Maheswari
3	Ram chandra Reddy	CE	189Y1A0109	Ram chandra Reddy
4	M. Ginni Kumar	EEE	189Y1A0233	M. Ginni Kumar
5	P. Pawan	EEE	189Y1A0236	P. Pawan
6	S. Keerthi	EEE	189Y1A0241	S. Keerthi
7	shaik. Khaleefa	EEE	189Y1A0244	S. Khaleefa
8	shaik. Nazeer Basha	EEE	189Y1A0246	S. N. Basha
9	V. Pavan Kumar Reddy	EEE	189Y1A0251	V. Pavan Kumar Reddy
10	V. Venkatesh	EEE	189Y1A0252	V. Venkatesh
11	V. Yogaswara	EEE	189Y1A0253	V. Yogaswara
12	C. Venkata Siva Reddy	CSE	189Y1A0522	C. Venkata Siva Reddy
13	C. Sainath Reddy	CSE	189Y1A0523	C. Sainath Reddy
14	C. Ashish	CSE	189Y1A0524	C. Ashish
15	C. Jayanth	CSE	189Y1A0527	C. Jayanth
16	D. Manoj Kumar Reddy	CSE	189Y1A0528	D. Manoj Kumar Reddy
17	E. Kiran Kumar	CSE	189Y1A0535	E. Kiran Kumar
18	E. Harshitha	CSE	189Y1A0537	E. Harshitha
19	B. Nikhitha	CSE	189Y1A0542	B. Nikhitha

20	Gr Sai chaitanya Reddy	CSE	189Y1A0549	G. Saichuan
21	Gr. Lakshmi kanth Vasa Reddy	CSE	189Y1A0550	Gr. Lakshmi
22	D. Santhosh komar	CE	189Y1A0124	D. Santhosh
23	D. SiVaSankar Reddy	CE	189Y1A0125	D. SiVaSankar
24	D. Venkata jithendra Reddy	CE	189Y1A0126	D. Venkata jithendra
25	H. Aravindra Reddy	CE	189Y1A0129	H. Aravindra Reddy
26	G. premkumar	CE	189Y1A0130	G. premkumar
27	G. Nithesh	CE	189Y1A0134	G. Nithesh
28	H. Sree Veni	CE	189Y1A0135	H. Sreeveni
29	J. Gangaraju	CE	189Y1A0137	J. Gangaraju
30	J. Aravindu	CE	189Y1A0139	J. Aravindu
31	J. Jahnavi	CE	189Y1A0140	J. Jahnavi
32	K. Venkata Sachin Reddy	CE	189Y1A0142	K. Venkata Sachin
33	K. Sireesha	CE	189Y1A0143	K. Sireesha
34	K. Bharanumanikanta Reddy	CE	189Y1A0144	K. Bharanumanikanta
35	K. Sunil Kumar	CE	189Y1A0148	K. Sunil Kumar
36	L. Venkataiah	CE	189Y1A0153	L. Venkataiah

Coordinator

HOD/H&S
Dr. I. SREEVANI M.Sc., Ph.D
Head of Humanities & Sciences
K.S.R.M College of Engineering
KADAPA 515005



K.S.R.M. COLLEGE OF ENGINEERING

(UGC-AUTONOMOUS)

Kadapa, Andhra Pradesh, India- 516 003

Approved by AICTE, New Delhi & Affiliated to JNTUA, Ananthapuramu.

An ISO 14001:2004 & 9001: 2015 Certified Institution

Activity Report

Name of the Activity	Awareness Program on Importance of Communication Skills	
Type of Activity	Student Centric Event	
Date and Time of Activity	24-01-2019	10:00 A.M
Details of Participants	36 students	
Coordinator(s)	Sri. K. Eswara Reddy, Asst. prof, Dept. of H&S	
Organizing Dept./Support System	Department of Humanities and Sciences	
Description	<p>Awareness Program on Importance of Communication skills was organized by Department of H&S on 24-01-2019 in Communicative English Lab at 10.00 am. The main aim of the program is to enhance their communication skills – both oral and written. During the session, Sri. N. Bhaskara Reddy made a brief review on Basic Writing Skills which covered areas like Punctuation, Commonly Confused words and Basic Grammar. The resource person gave some useful information and tips on drafting business/official letters and the participants were asked to work in groups and write out formal letters making use of the tips and following the guide lines given. After the groups finished writing, some of them were asked to read out the letter drafted by their group and they were given suggestions as how the letters could have been made more appropriate and effective. Around 36 students participated in the program. The program was concluded with vote of thanks by Sri. K. Eswara Reddy, Asst. Prof, Dept. of H&S.</p>	



Photos

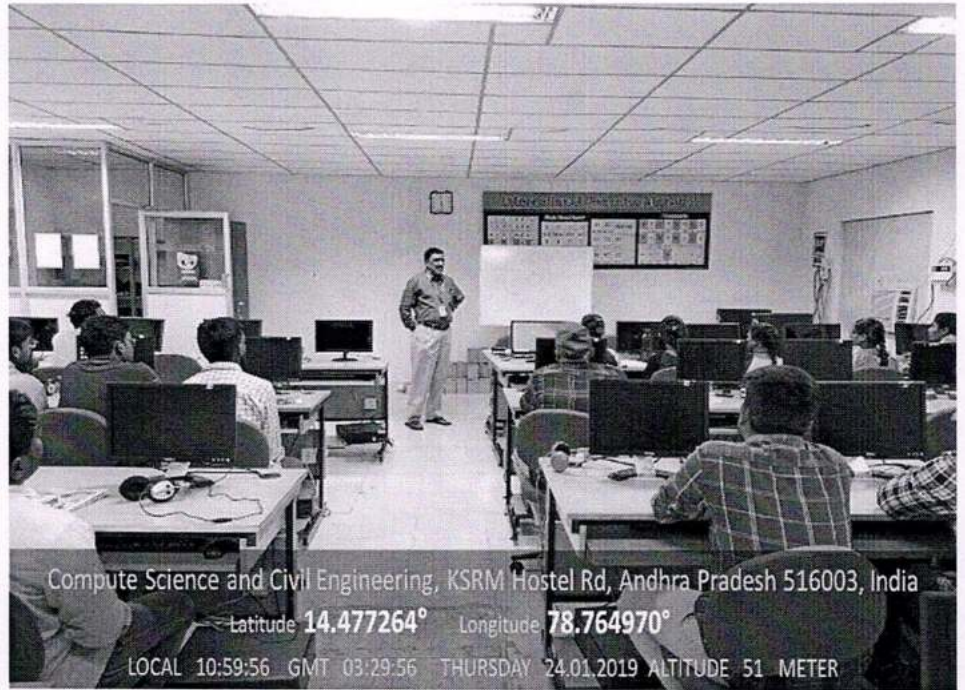

Sri. N. Bhaskara Reddy, Speaker addressing the students

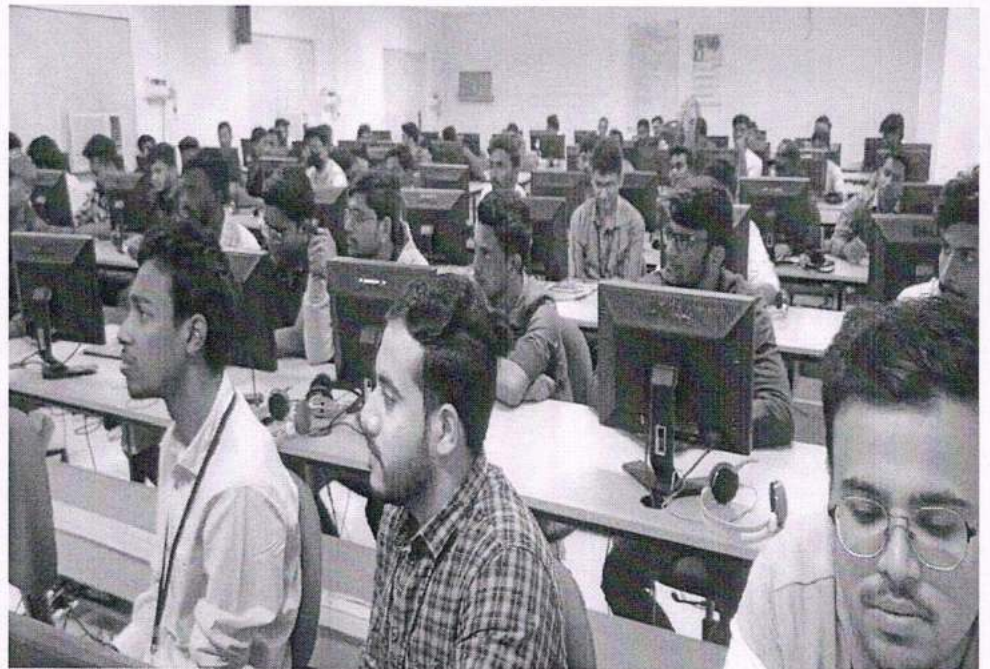

Students listening to speaker



Compute Science and Cvil Engineering, KSRM Hostel Rd, Andhra Pradesh 516003, India

Latitude **14.477243°** Longitude **78.764935°**

LOCAL 11:25:06 GMT 04:55:06 THURSDAY 24.01.2019 ALTITUDE 50 METER

Interaction of students with Coordinator Sri. K. Eswara Reddy

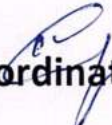
Coordinator

HOD

Dr. I. SREEVANI M.Sc.,Ph.D
Head of Humanities & Sciences
K.S.R.M College of Engineering
KADAPA - 516 005